

Expert Power Control 8291-2

Manual





Table of contents

1.	Device Description	5
1.1	Safety Information	6
1.2	Content of Delivery	10
1.3	Description	11
1.4	Installation	12
1.5	Structure EPC 8291	13
1.6	Residual Current Type A	15
1.7	Overvoltage Protection	16
1.8	Technical Specifications	16
1.8.1	Electrical Measurement	17
1.9	Sensor	17
1.9.1	Calibration	21
2.	Operating	22
2.1	Operating the device directly	23
2.2	Control Panel	23
2.3	Maintenance	25
2.3.1	Maintenance Page	28
2.3.2	Configuration Management	29
2.3.3	Bootloader Activation	30
3.	Configuration	33
3.1	Power Ports	34
3.1.1	Watchdog	35
3.2	Ethernet	37
3.2.1	IP Address	38
3.2.2	IP ACL	39
3.2.3	HTTP	40
3.2.4	802.1X	42
3.3	Protocols	43
3.3.1	Console	43
3.3.2	Syslog	45
3.3.3	SNMP	45
3.3.4	Radius	47
3.3.5	Modbus TCP	48
3.3.6	MQTT	49
3.4	Clock	50
3.4.1	NTP	50
3.4.2	Timer	51
3.4.3	Timer Configuration	51
3.5	Sensors	57

Table of contents

3.5.1	Port Switching	59
3.6	E-Mail	60
3.7	Front Panel	62
3.8	Fan	62
4.	Specifications	63
4.1	Automated Access	64
4.2	802.1X Authentication	64
4.3	Console	65
4.3.1	SSH	70
4.3.2	Console Cmd 8291-2	71
4.3.3	Serial Console	82
4.4	HTTP Authentication	83
4.5	IP ACL	84
4.6	IPv6	85
4.7	Messages	85
4.8	Modbus TCP	87
4.8.1	Sensor Tables	93
4.9	MQTT	95
4.9.1	Example HiveMQ	97
4.10	Radius	98
4.11	SNMP	99
4.11.1	Device MIB 8291	101
4.12	SSL	104
5.	Support	106
5.1	Data Security	107
5.2	HTTP Performance	107
5.3	Contact	108
5.4	Declaration of Conformity	109
5.5	FAQ	109
Index		112

Device Description

1 Device Description

1.1 Safety Information

1. Introduction

Dear Customer,

Thank you for choosing GUDE. We take pride in developing and manufacturing high-quality products tailored to meet your needs. Our solutions are built to deliver reliability and a long lifespan. This User Manual is here to help you make the most of your GUDE product, ensuring safe and sustainable use for years to come.

IMPORTANT! READ THIS USER MANUAL BEFORE USING THE DEVICE AND KEEP IN A SAFE PLACE FOR REFERENCE.

2. Guide to using this manual

2.1 Applicable regulations

The local safety regulations apply.

2.2 Warning Notices in Text



DANGER

- This notice refers to risks which result in serious or fatal injury.
- Serious or fatal injuries can be avoided by taking the precautions mentioned.



WARNING

- This notice refers to risks which can result in serious or fatal injury.
- Serious or fatal injuries can be avoided by taking the precautions mentioned.

2.3 Symbols in Text



- This symbol refers to a chapter in this User Manual.



- This notice requires increased attention.

2.4 Symbols on device

Meanings of symbols that may be on the device:



The device may only be connected to a properly grounded socket.



Do not dispose of the product with your household waste.



Read and understand the User Manual and keep it in a safe place for reference.

3. Safety Precautions

3.1 Warning Symbols

Meaning of warning symbols on the device:



HAZARD OF ELECTRIC SHOCK, EXPLOSION, OR ARC FLASH



WARNING OF OVERVOLTAGE



READ AND UNDERSTAND THE USER MANUAL AND KEEP IT IN A SAFE PLACE FOR REFERENCE



PROTECT THE DEVICE FROM RAIN AND DAMPNES

3.2 Intended Use

The device is intended for customers who set up, install, relocate, or maintain devices of GUDE. It is to be installed and operated by a skilled person in a controlled location with restricted access. Use it only indoors in a dry location.



WARNING

- Using the device for purposes for which it is not designed may result in serious or fatal injuries and damage to property.
- Always use the device as described in this User Manual.

3.3 Requirements for Users



WARNING

- Users without adequate training or instruction cannot recognize or assess the risks involved in using the device. The user or other persons may sustain serious or fatal injuries.
- Read and understand the User Manual and keep it in a safe place for reference.
- When passing the device on to another person: always include the User Manual.
- Make sure that the user meets the following conditions:
 - The user is rested.
 - The user must be in good physical condition and mental health to operate the device. If the user is able to operate the equipment but is physically, hearing, visually or mentally impaired, the user may only work with the equipment under the supervision of or after receiving instruction from a responsible person.
 - The user is able to recognize and assess the risks involved in using the device.
 - The user is an adult or is being trained in an occupation under supervision according to national regulations.
 - The user has received instruction from a GUDE partner or other experienced user before using the device for the first time.
 - The user is not under the influence of alcohol, medication or drugs.
 - If you are unsure: Consult a GUDE partner.

3.4 Working Area and Surroundings





WARNING

- Bystanders, children and animals are not aware of and cannot assess the dangers of the device or electric current.
- Bystanders, children and animals may be seriously or fatally injured.
- Keep bystanders, children and animals away from the work area.

Device Description

- Make sure that children cannot play with the device.
- The device is not waterproof. If it is operated in the rain or in a damp environment, the user may suffer an electric shock. The user may be injured and the device may be damaged.
- Do not operate it in the rain or in a damp environment.
- The device is not protected against all ambient conditions. If it is exposed to certain ambient conditions, it may catch fire or explode. This may result in serious injury to people and damage to property.
- Operate the device in an enclosed, dry room.
- Do not operate the device in highly flammable or explosive environments.
- Do not operate the device on a highly flammable surface.

- Do not use or store the device outside of the specified temperature limits,  see Technical Data .
- People may trip over the connecting cable. People may be injured, and the device may be damaged.
- Lay the connecting cable flat on the floor or against the wall.

3.5 Safe Operating Condition

The device is in safe condition when the following conditions are met:

- The device is undamaged.
- The device is clean and dry.



WARNING

- If not in safe condition, components may no longer operate correctly, and safety devices may be rendered ineffective. People may be seriously injured or killed.
- Never use a damaged device.
- If the device is dirty or wet: clean the device and allow it to dry.
- Do not modify the device.
- Never insert objects in the openings of the device.
- Never bridge the electric contacts of the device with metallic objects (short circuit).
- Do not open the device.
- Replace worn or damaged warning signs.
- If you are unsure: Consult a GUDE partner.

3.6 Use



WARNING

- A damaged or defective device may produce an unusual smell or emit smoke when in use. People may be injured or property may be damaged. Disconnect the mains plug from the socket.
- In the event of inadequate heat dissipation, the device may overheat and cause a fire. People may be seriously or fatally injured, and property may be damaged.
- Do not cover the device.

3.7 Connecting to the power supply

- Contact with current-carrying components may occur for the following reasons:
 - The connecting cable or the extension cord is damaged.
 - The mains plug of the connecting cable or extension cord is damaged.
 - The socket connected to the mains is not installed correctly.



DANGER

- Contact with current-carrying components may result in electric shock. This may res-

ult in serious or fatal injury to the user.

- Make sure that the connecting cable, extension cord and their mains plugs are undamaged.
- A damaged or unsuitable extension cable can result in electric shock. There is a risk of serious or fatal injury.
- If the connecting cable or the extension cord is damaged:
 - Do not touch the damaged area.
 - Disconnect the mains plug from the wall socket.
 - Make sure your hands are dry before touching the connecting cable, extension cord and their mains plug.
 - Plug the mains plug of the connecting cable or extension cord into a properly installed socket.
 - Connect the device with a fault current circuit breaker (30 mA, 30 ms).
- Use an extension cable with the correct cable cross-section.



WARNING

- Overvoltage can occur in the device if the line voltage or mains frequency are incorrect during operation. People may be injured, and the device may be damaged.
- Make sure the line voltage and mains frequency match the data on the rating label of the device.
- If the device is not connected to a properly secured power circuit, the power circuit may be overloaded. Damage to property may occur.
- Use the device only on an individually secured socket with a ground contact.
- Do not connect any other electric consumers to the same power circuit.
- An incorrectly routed connecting cable or extension cord may be damaged, and people may trip over it. People may be injured, and the connecting cable or extension cord may be damaged.
- Route and mark the connecting cable and extension cord so that people will not trip over them.
- Route the connecting cable and extension cord so that they are not under tension or tangled.
- Route the connecting cable and extension cord so that they will not be damaged, kinked or crushed and will not be chafed.
- Protect the connecting cable and extension cord from heat, oil and chemicals.
- Lay the connecting cable and extension cord on a dry surface.
- The extension cable warms up in operation. If that heat cannot escape, it may cause a fire.
- When using an extension cable: completely unroll the extension cable.
- If electric wiring and conduits are routed in the wall, they may be damaged if the device is mounted on the wall. Contact with wiring can result in electric shock. This may result in serious injury to people and damage to property.
- Make sure there is no wiring or pipes in the wall at the proposed mounting site.

3.8 Transporting



WARNING

- The device can tip over or move while being transported. People may be injured or property may be damaged.
- Secure the device with lashing straps, belts or a net to prevent it from tipping over or moving. Ideally, use the padded shipping carton in which the appliance was delivered.
- Disconnect the mains plug from the socket.
- Disconnect the connected consumers.
- Roll up the connecting cable.
- Grip the device by the housing and hold it firmly.
- The connecting cable must not be used for carrying the device. The connecting

cable and the device may be damaged.

3.9 Storage

WARNING

- Children are not aware of and cannot assess the dangers of a device. Children can be seriously injured or killed.
- Store the device out of the reach of children.
- The device is not protected against all ambient conditions. If the device is exposed to certain ambient conditions, it may get damaged.
- Disconnect the plug from the socket.
- Roll up the connecting cable.
- Store the device in clean and dry conditions.
- Store the device in an enclosed space.
- Do not store the device outside of the specified temperature limits,  see Technical Data ¹⁶.
- The connecting cable must not be used for carrying or suspending the device. This may cause the connecting cable or the device to get damaged.
- Attach the device at the provided mounting brackets.

3.10 Cleaning, Maintenance and Repair

WARNING

- Harsh detergents, cleaning with a water jet or sharp objects can damage the device. If it is not cleaned correctly, components may no longer function properly or safety devices may be rendered inoperative. People may suffer serious injuries as a result.
- Disconnect the mains plug from the socket.
- Clean the charging management with a damp cloth.
- If the device is not serviced or repaired correctly, components may no longer function properly or safety devices may be rendered inoperative. People may suffer serious or fatal injuries as a result.
- If the connecting cable is faulty or damaged: Replace the connecting cable.
- The device cannot be serviced or repaired by the user.
- If your device has a malfunction or is damaged or requires servicing: Contact your GUDE partner.

1.2 Content of Delivery

The package includes:

- **Expert Power Control 8291-2**
- 1 x Power Supply cable (IEC C19, max. 16 A)
- Quick Start Guide

1.3 Description

The **Expert Power Control 8291-2** has 17 DC switchable power outlets with voltages of 24 V, 12 V and 5 V and 4 AC (IEC C13, max. 10A) switchable power outlets

- 21 Power Ports (17 DC and 4 AC) individually switchable directly on the device
- Zero-Voltage Switching (switching of the relay at the zero crossing of the voltage curve)
- Integrated power supply unit (max. 300 W) with active power factor correction (PFC)
- Monitoring for 5 V, 12 V and 24 V (Bank A-D) of current, voltage and energy
- Monitoring of all eFuses for 5 V, 12 V and 24 V (Ports A1 - D4) of current, voltage and energy
- Voltage boost for eFuses with 5V or 12V
- Maximum available DC current per port: max. 4 A
- Current segmentation per bank: 5 V: max. 8,8 A, 12 V: max. 6 A, 24 V: max. 12,5 A
- AC: Metering of energy, current, power factor, phase angle, frequency, voltage and active / apparent / reactive power
- AC: Residual current metering type A
- 2x four-digit 7-segment LED displays
- Integrated overvoltage protection (SPD) type 3
- Each DC outlet protected by eFuses in case of short circuits
- 2 interfaces for optional sensors for environmental monitoring
- RJ45 network connection and RS232 interface
- Console commands via SSH, Telnet and serial interface
- SSH support with public key and passwords
- Individually parameterisable switch-on delay of all outputs
- Programmable timetables and turn-on/turn-off sequences
- Individually adjustable watchdog for each output, which switches depending on accessibility (network ping)
- Dual TCP/IP stack with IPv4 and IPv6 support (IPv6-ready)
- Control and monitoring of the device via Ethernet with an integrated web server with SSL encryption (TLS 1.1, 1.2, 1.3)
- Control and configuration with CGI parameters and JSON messages via HTTP(S) using REST API
- SNMP (v1, v2c and v3, traps)
- MQTT 3.1.1 Support
- Modbus TCP support
- 802.1X Port-Based Authentication
- Radius support
- Generation of messages (e-mail, syslog and SNMP traps) and switching of relays depending on sensor measurement limits
- Firmware update during operation via Ethernet possible
- Encrypted e-mails (SSL, STARTTLS)
- Access protection through IP access control
- Low own consumption
- Developed and produced in Germany

1.4 Installation

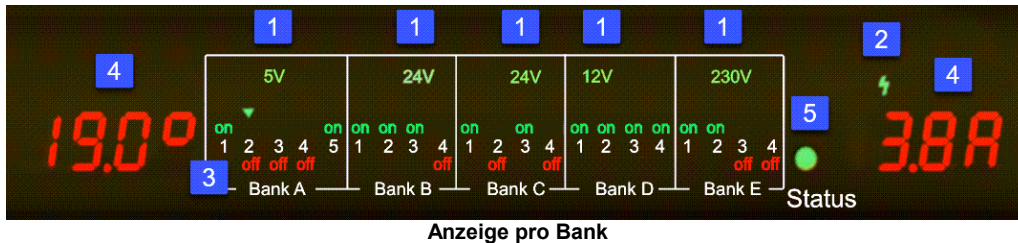

1. LED indicators (5V, 12V, 24V, 230V) for bank voltage display
2. LED indicator (flash) for Over Voltage Protection (green - surge protection is active, red - inactive)
3. 21 plain text displays (on/off) for the state of the outputs (Bank A to Bank E)
4. 2 x 7-segment display for measured values
5. Status LED

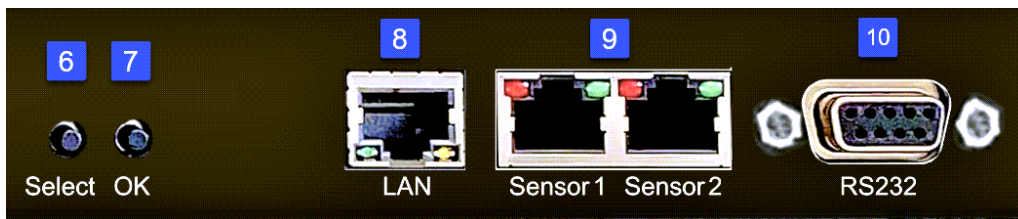

6. Select button
7. OK button
8. Ethernet connector (RJ45)
9. 2 x External sensor connectors (RJ45)
10. RS232 connector



11. Mains supply (IEC C20, max.16A)
12. 4 x Load outputs Bank E (IEC C13, max. 16A)

Device Description

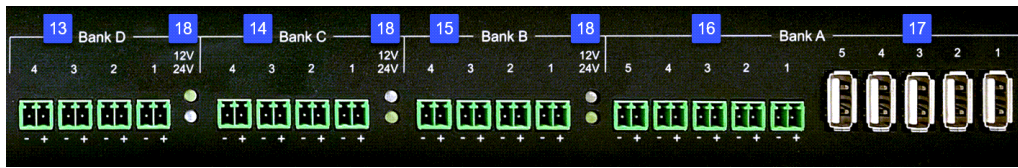

- 13. 4 x Industrial terminal 2-pole (Bank D)
- 14. 4 x Industrial terminal 2-pole (Bank C)
- 15. 4 x Industrial terminal 2-pole (Bank B)
- 16. 5 x Industrial terminal 2-pole (Bank A)
- 17. 5 x USB socket Type A (Bank A)
- 18. 3 x LED indicators 12V / 24V selected

 The USB ports are for power supply only, no data communication takes place.

Start-up the device

- Connect the power cord (IEC C19, max. 16A) to the mains supply. The cable connectors are secured as regards their type against unintentional loosening. They must be inserted up to the stop, otherwise there is no secure connection. The plug must not wobble in the socket, or there is no tight connection.
- Plug the network cable into the Ethernet socket (RJ45).
- If required, setup a serial connection to the RS232 port.
- Insert the optional external sensors into the sensor connectors.
- Connect the consumers with the load outputs (IEC C13, max. 10A).
- Connect the consumers with the Industrial terminal or USB sockets.

1.5 Structure EPC 8291

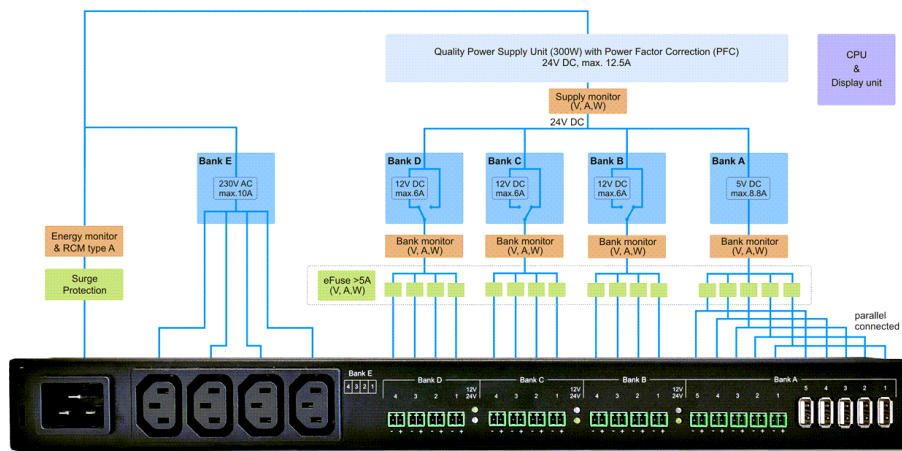

The **Expert Power Control 8291** has 17 x DC switchable outputs with voltages of 12V, 24V and 5V as well as 4 x AC switchable outputs. The outputs are divided into 5 different banks:

Device Description

- Bank A with 5V (max. 8.8 A)
- Bank B with 12V (max. 6.0 A) or 24V (max. 12.5 A)
- Bank C with 12V (max. 6.0 A) or 24V (max. 12.5 A)
- Bank D with 12V (max. 6.0 A) or 24V (max. 12.5 A)
- Bank E with 230V (max. 10 A)

The voltage selection (12V or 24V) of the banks B to D is indicated by LEDs on the front panel and on the back.

Voltage sources in the EPC 8291

The 230V mains voltage feeds the built-in 24V power supply unit (300 W) of the device. On the web page (Control Panel) the measurements of the DC voltage sources S1 to S5 are displayed. Here corresponds:

- S1 - 5V DC (max. 8.8 A) for Bank A fed from 24V
- S2 - 12V DC (max. 6.0 A) for bank B fed from 24V
- S3 - 12V DC (max. 6.0 A) for Bank C fed from 24V
- S4 - 12V DC (max. 6.0 A) for Bank D powered from 24V
- S5 - 24V DC (max. 12.5 A) fed from 230V mains voltage

S1	5.026 V DC		2.025 A / 8.8 A
S2	11.982 V DC		0.000 A / 6.0 A
S3	12.000 V DC		0.000 A / 6.0 A
S4	12.000 V DC		0.000 A / 6.0 A
S5	24.041 V DC		0.436 A / 12.5 A

In this example you can see that the voltage source S1 (bank A) is fed by the source S5 (24V power supply). The consumption at S1 is also reflected at S5.

Measuring points of the voltage sources

The device has a current and voltage measurement at the following locations in the device:

- Bank A 5V DC (Bank monitor) display on the website Bank A
- Bank B 12V / 24V DC (Bank monitor) Display on the website Bank B
- Bank C 12V / 24V DC (Bank monitor) Display on the website Bank C
- Bank D 12V / 24V DC (Bank monitor) Display on the website Bank D
- 24V power supply (Supply monitor) Display on the website as "S5"
- 230V power supply (Energy monitor & RCM type A) on the website as "L1 Meter12"

Critical voltage and current values

If the voltage measurement falls below minimum values, the voltage indicator LED on the front panel changes from green to red. If the current of a bank or 24V power supply exceeds a critical value, the voltage indicator LED flashes.

Error case	5V	12V	24V	230V
Voltage undershot (red LED)	< 4,75V	< 11,4V	< 22,8V	< 80V

Device Description

Current exceeded (flashing LED)	> 8,8 A	> 6,0 A	> 12,5 A	> 16 A
---------------------------------	---------	---------	----------	--------

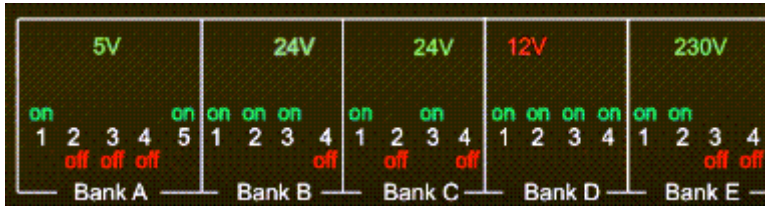

Here the voltage at bank D has fallen below 11.4V.

Use of eFuses

In the device, the DC power sources are protected by resettable electronic fuses (eFuses). These fuses are triggered by short circuit or overload. If an eFuse is triggered, the output is switched off. The device then also automatically switches off the port (front LEDs go from "on" to "off"). When the port is turned on again, the eFuse is reset and the output will operate normally until another short circuit or overload occurs. Triggering of an eFuse is indicated on the front panel LEDs by a flashing green triangle above a port number. The following states exist for an eFuse:

State	Number	Web Icon	Frontpanel LED
switched off (Ok)	0		
switched on (Ok)	1		
eFuse triggered (Error 1)	2		flashing triangle
External voltage source (Error 2)	3		flashing triangle

The numbers (0 - 3) of eFuses are returned by console commands, SNMP and Modbus TCP as eFuse state description.

Operating external voltage sources at the outputs of the EPC 8291-1 can cause damage to the device.

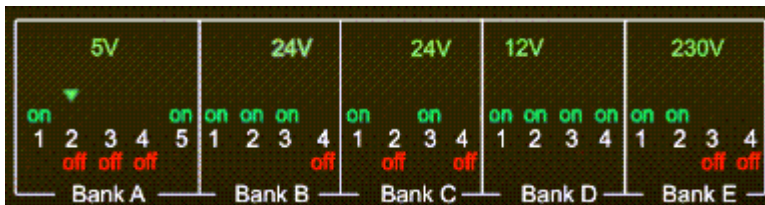

In this example an overload has occurred on port 2 of bank A.

1.6 Residual Current Type A

This device measures Residual Current type A (also known as fault current) for sinusoidal alternating currents and pulsating direct fault currents.

Device Description

PF	Residual Current AC rms mA	total En activ kW
1.00	0.1	

Residual Current is displayed in the web interface, but can also be queried via the other protocols.

1.7 Overvoltage Protection

The device contains an overvoltage protection at each of the banks. The protection is based on input side varistors with thermal fuse between phase (L) and neutral (N) to protect the internal electronics and power ports with failure detection (permanently triggered thermal fuse). The state of the protection is indicated on the front panel by a green or red flash. A green flash means that the protection is active, a red flash symbolizes that the overvoltage protection fails. In addition, the status of the overvoltage protection can be seen on the Webpage (HTTP) and acquired with SNMP. In the web interface (Control Panel), the proper state is marked as "OVP operational. Each surge protection module is designed that it can derive a practical unlimited number of voltage pulses in normal installation environments. In an environment with many energy rich surge pulses it can result in permanent loss of function due to aging of the overvoltage protection element.

 Recovering of the overvoltage protection function can only be performed by the manufacturer of the device. In the normal case, the device will continue to work even after the failure of the protective function.

 A signaling via E-Mail, Syslog or SNMP trap occurs only once during operation, exactly at the moment in which the protection fails. In addition, at the start up of the device a message is generated, when the overvoltage protection is not active.

1.8 Technical Specifications

Interfaces	1 x Ethernet port (RJ45) 1 x Serial connector (D-SUB, RS232) 1 x Mains supply (IEC C20, max. 16 A) 5 x USB socket Type A (5V, max. 3.5 A) 5 x DC outputs (5V, max. 3,5 A) 12 x DC outputs (12V / 24V, max. 4 A) 4 x Load outputs (IEC C13, max. each 10 A, total 16 A) 2 x RJ45 for external sensor
Plug for DC outputs	System terminal 2-pole - AK1550/2-3.5-GREEN
Network connectivity	10/100 MBit/s Ethernet RJ45
Power Supply	internal power supply (100 - 240V AC / -10% / +10%)
Overvoltage Protection	Type 3

Device Description

Overvoltage category (OVC)	OVC II
Environment <ul style="list-style-type: none"> • Operating temperature • Storage temperature • Humidity 	0°C - 40 °C (32 °F - 104 °F) -20°C - 70 °C (-4 °F - 158 °F) 0% - 95% (non-condensing)
Case	powder coated, galvanized steel sheet
Measurements	19" (inches), 1 Rack Unit, (Depth 241 mm / 9,6 inch)
Weight	approx. 4.4 kg (9.7 lb)

1.8.1 Electrical Measurement

typical fault tolerances for Ta=25°C, I=1Arms...16Arms, Un=90Vrms...265Vrms

Electrical Measurement Specification				
Category	Range	Unit	Resolution	Inaccuracy (typical)
Voltage	90-265	V	0.01	< 1%
Current	0 - 16	A	0.001	< 1.5%
Frequency	45-65	Hz	0.01	< 0.03%
Phase	-180 - +180	°	0.1	< 1%
Active power	0 - 4000	W	1	< 1.5%
Reactive power	-4000 - 4000	Var	1	< 1.5%
Apparent power	0 - 4000	VA	1	< 1.5%
Power factor	0 - 1	-	0.01	< 3%
Energy Counter				
Active Energy (total)	9.999.999,999	kWh	0.001	< 1.5%
Active Energy (resettable)	9.999.999,999	kWh	0.001	< 1.5%

Measurement accuracy DC	
Voltage internal sources S1...S5	better $\pm 3\%$ of measured value $\pm 0.1V$
Current Bank A...D + S5 (pure resistive loads)	better $\pm 3\%$ of measured value $\pm 0.1A$

1.9 Sensor

Two external sensors can be connected to the **Expert Power Control 8291-2**. The following sensors are currently available

Device Description

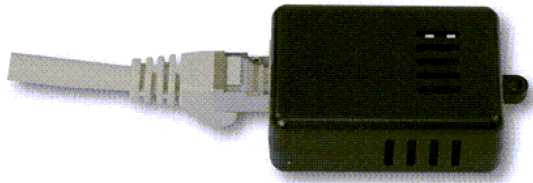

7201, 7202



7205, 7206

Product Name	7201 (End-of-Life)	7202 (End-of-Life)	7205	7206
Connector	RJ45	RJ45	RJ45	RJ45
temperature range	-20°C to +80°C at ±2°C (maximum) and ±1°C (typical)	-20°C to +80°C at ±2°C (maximum) and ±1°C (typical)	-20°C to +80°C at ±2°C (maximum) and ±1°C (typical)	-20°C to +80°C at ±2°C (maximum) and ±1°C (typical)
	-4°F to +176°F at ±3.6°F (maximum) and ±1.8°F (typical)	-4°F to +176°F at ±3.6°F (maximum) and ±1.8°F (typical)	-4°F to +176°F at ±3.6°F (maximum) and ±1.8°F (typical)	-4°F to +176°F at ±3.6°F (maximum) and ±1.8°F (typical)
air humidity range (non-condensing)	-	0-100%, ±3% (typical)	0-100%, ±3% (typical), 10-80% ±2% (typical)	0-100%, ±3% (typical), 10-80% ±2% (typical)
air pressure range (full)	-	-	-	± 1 hPa (typical) at 300 ... 1100 hPa, 0 ... +40 °C (32 ... +104 °F)
air pressure range (extended)	-	-	-	± 1.7 hPa (typical) at 300 ... 1100 hPa, -20 ... 0 °C (-4 ... 32 °F)



7207, 7209, 7210

Device Description

Product Name	7207	7209	7210
Connector	RJ45	RJ45	RJ45
temperature range	-20°C to +80°C at ±2°C (maximum) and ±1°C (typical)	-20°C to +80°C at ±2°C (maximum) and ±1°C (typical)	-20°C to +80°C at ±2°C (maximum) and ±1°C (typical)
	-4°F to +176°F at ±3.6°F (maximum) and ±1.8°F (typical)	-4°F to +176°F at ±3.6°F (maximum) and ±1.8°F (typical)	-4°F to +176°F at ±3.6°F (maximum) and ±1.8°F (typical)
air humidity range (non-condensing)	-	0-100%, ±3% (typical), 10-80% ±2% (typical)	0-100%, ±3% (typical), 10-80% ±2% (typical)
air pressure range (full)	-	-	± 1 hPa (typical) at 300 ... 1100 hPa, 0 ... +40 °C (32 ... +104 °F)
air pressure range (extended)	-	-	± 1.7 hPa (typical) at 300 ... 1100 hPa, -20 ... 0 °C (-4 ... 32 °F)
Inputs	2x	2x	2x



7101



7104 - 7106

Product Name	7101 (End-of-Life)	7104-1 (End-of-Life)	7105-1 (End-of-Life)	7106-1 (End-of-Life)
Calibrated Sensor	-	7104-2 (End-of-Life)	7105-2 (End-of-Life)	7106-2 (End-of-Life)
Cable Length	≈ 2m (78.74 inch)	≈ 2m (78.74 inch)	≈ 2m	≈ 2m
Connector	RJ45	RJ45	RJ45	RJ45
temperature range	-20°C to +80°C at ±2°C (maximum) and ±1°C (typical)	-20°C to +80°C at ±2°C (maximum) and ±1°C (typical)	-20°C to +80°C at ±2°C (maximum) and ±1°C (typical)	-20°C to +80°C at ±2°C (maximum) and ±1°C (typical)
	-4°F to +176°F at ±3.6°F (maximum) and ±1.8°F (typical)	-4°F to +176°F at ±3.6°F (maximum) and ±1.8°F (typical)	-4°F to +176°F at ±3.6°F (maximum) and ±1.8°F (typical)	-4°F to +176°F at ±3.6°F (maximum) and ±1.8°F (typical)
air humidity range (non-condensing)	-	-	0-100%, ±3% (typical), 10-80% ±2% (typical)	0-100%, ±3% (typical), 10-80% ±2% (typical)
air pressure range (full)	-	-	-	± 1 hPa (typical) at 300 ... 1100 hPa, 0 ... +40 °C (32 ... +104 °F)
air pressure range (extended)	-	-	-	± 1.7 hPa (typical) at 300 ... 1100 hPa, -20 ... 0 °C (-4 ... 32 °F)

Device Description

Technical data inputs

Inputs	digital input, internal pull-up active: max. 24V, < 3V Low, > 8V High passive: switching contact
Terminal	3-pole - AK1550/3-3.5-GREEN

Behavior inputs

Input	Logic	Logic inverted (Fabdefault)
open	High / on / closed	low / off / open
closed	Low / off / open	High / on / closed
Voltage		
< 3V	Low / off / open	High / on / closed
> 8V	High / on / closed	Low / off / open
otherwise	undefined	undefined

 Event messages are generated when the logic changes. In the sensor configuration the logic can be inverted. So that "High" appears when the input is closed, the logic is configured as inverted as fabdefault. In protocols with numeric values (e.g. SNMP or ModbusTCP) a "1" is considered as High, and a "0" as Low.

Sensor in web interface



The sensors are automatically detected after connect. This is indicated by the green LED on the sensor port that is lit permanently. The sensor values are displayed at the "Control Panel" web page:

Id	Name	Temperature °C	Humidity %	Dew Point °C	Dew Diff °C	Pressure hPa
1: 7106	7106	22.4	56.6	13.4	9.1	1005.2

A click on the link in the "Name" column opens the display of the Min and Max values. The values in a column can be reset using the "Reset" button. The "Reset" button in the name column deletes all stored Min and Max values.

Id	Name	Temperature °C	Humidity %	Dew Point °C	Dew Diff °C	Pressure hPa
1: 7106	7106	22.4	56.8	13.4	9.0	1005.3
	24h min	22.3	55.6	13.1	9.0	1000.3
	24h max	22.4	56.8	13.4	9.3	1005.3
	<input type="button" value="Reset"/>	<input type="button" value="Reset"/>	<input type="button" value="Reset"/>	<input type="button" value="Reset"/>	<input type="button" value="Reset"/>	<input type="button" value="Reset"/>

If external sensors with inputs are connected, these are also added on the "Control Panel" web page:

Port	Name	logical state	time since transition	toggle count
2: 7207 - I1	Extern Input	 0: off / open	1d 03:48:48	0
2: 7207 - I2	Extern Input	 0: off / open	1d 03:48:48	0

1.9.1 Calibration

With the actual firmware version it is possible to store a value offset into the sensor. This offset is zero by default, because the sensors are normally not calibrated. The offset can be specified by the following commands via Telnet / SSH:

```
extsensor {port_num} {sen_field} calib set {float}
extsensor {port_num} {sen_field} calib show
```

 For devices with internal sensors (such as the Expert Sensor Box), the internal sensor port is 1. The temperature or air pressure unit depends on the configuration..

External Sensor Field Table "{sen_field}".

Index	Description	Unit
0	Temperature	°C / °F
1	Humidity	%
3	Air pressure	hPa / inHg

Operating

2 Operating

2.1 Operating the device directly

Port Switching

The current switching state of the output is indicated by the corresponding plain text displays (port LEDs). If the green "on" LED is lit, the port is switched on, if the red "off" LED is lit, the output port is switched off. The buttons "Select" and "Ok" are located on the device. If you press "select", you can select the following modes one after the other (in the front panel  configuration you can deactivate the modes "All on" or "All off").

1. All on (PALL in the display): All LEDs flash green. If you press the "Ok" button for 2.5 seconds, all ports are switched on.
2. All off (PALL in the display): All LEDs flash red. If you hold the "Ok" button for 2.5 seconds, all ports are switched off.
3. If you press "Select" again, the LED for the first output starts flashing, i.e. the output is selected. Press "Select" again to select the next output. Pressing and holding the "Ok" button for one second will toggle the state of the selected output.

 If the ports are already "All on" or "All off", the corresponding mode is skipped.

Display Information

If no port is selected manually, repeatedly pressing the "ok" button will show the IP-address and the values of the external sensors on the display.

Status-LED

The Status LED shows the different states of the device:





















- red: The device is not connected to the Ethernet.
- orange: The device is connected to the Ethernet and waits for data from the DHCP server.
- green: The device is connected to the Ethernet and the TCP/IP settings are allocated.
- evenly blinking: The device is in Bootloader mode.

If 802.1X is active:

- Flashing: long orange - short off: 802.1X authentication active
- Flashing: long orange - short red: 802.1X authentication error occurred

2.2 Control Panel

Access the web interface: `http://IP-address` and log-in.

Bank A - 5V		Bank B - DC 24V		Bank C - DC 12V		Bank D - DC 12V		Bank E - AC	
 A1:Power Port	0.000 A	 B1:Power Port	0.000 A	 C1:Power Port	0.000 A	 D1:Power Port	0.000 A	 E1:Power Port	
 A2:Power Port	0.003 A	 B2:Power Port	0.000 A	 C2:Power Port	0.002 A	 D2:Power Port	0.000 A	 E2:Power Port	
 A3:Power Port	0.000 A	 B3:Power Port	0.000 A	 C3:Power Port	0.000 A	 D3:Power Port	0.008 A	 E3:Power Port	
 A4:Power Port	0.003 A	 B4:Power Port	0.000 A	 C4:Power Port	0.000 A	 D4:Power Port D4	0.002 A	 E4:Power Port E4	
 A5:Power Port	0.000 A								
S1: 5.0 V DC 0.000 A		S5: 24.2 V DC 0.000 A		S3: 12.6 V DC 0.000 A		S4: 12.7 V DC 0.000 A		L1: 241.9 V AC OVP operational	

The web page provides an overview of the switching status and the current of the individual DC ports, and shows the measured values of the current banks A to E. The text "**OVP operational**" indicates that the Overvoltage protection is working. See chapter Overvoltage protection [16](#). If you click on an individual port, the buttons to check the port appear:

 B1: Power Port

		Voltage	Current	Power
Id	Name	V	A	W
B1	Power Port	0.00	0.000	0.00

The port icon is green when a port is on or red when it is off. The output can be switched manually using the "On" and "Off" buttons. If the output is switched on, it can be switched off by pressing "Reset" until it switches on again after a delay. This delay time is determined by the parameter Reset Duration, which is described in the chapter "Configuration - Power Ports [34](#)". The "Close" button makes the buttons disappear again. An additional small clock symbol indicates that a timer is active. Timers are activated by switch-on delay, reset or batch mode. A flash on the icon indicates an error condition of the eFuse.



An activated Watchdog is represented by an eye icon. An "X" means, that the address that should be observed, could not be resolved. Two circular arrows show a booting status.



The **All On** button switches the ports on in ascending order and **All Off** switches them off in descending order. The **Restart** command first switches off all ports that were configured as **on** or **remember last state** in the Coldstart status. These ports are then switched on again according to the coldstart delay. This corresponds to the cold start sequence when the device is switched on. The behavior here can sometimes seem complex, it is best to try it out for yourself for practice, e.g. if no loads are plugged in for the time being.

Batchmode

Each individual port can be set for a selectable period of time to the state "switch on" or "switch off". After the selected time they are automatically switched to the second preselected state.



Optionally the device can be switched via a Perl script or external tools like wget. More information is available on our support wiki at wiki.gude-systems.com.

Measured values mains connection and power sources

Id	Name	Voltage	Current	Freq	Phase	Power				Residual Current	total Energy	resettable Energy		Reset
		AC rms V	AC rms A	Hz	°	active W	reactive VAR	apparent VA	PF	AC rms mA	active kWh	active kWh	time h:m:s	
I1	Meter1	237.8	0.165	49.97	-82.7	6	-41	42	0.15	0.0	5.920	5.920	254 00:25:50	

For mains connection, current, voltage, phase angle, power factor, frequency, active, apparent, reactive and residual power are measured.



S1	5.026 V DC	2.025 A / 8.8 A
S2	11.982 V DC	0.000 A / 6.0 A
S3	12.000 V DC	0.000 A / 6.0 A
S4	12.000 V DC	0.000 A / 6.0 A
S5	24.041 V DC	0.436 A / 12.5 A

Display of voltage and current of each source S1 to S5.

2.3 Maintenance

The actual device generation with IPv6 and SSL allows all maintenance functions in the web interface to be carried out on the Maintenance Page [28](#).

Maintenance in the web interface

The following functions are available from the maintenance web page:

- Firmware Update
- Change the SSL certificate
- Load and save the configuration
- Restart the device
- Factory Reset
- Jump into the Bootloader
- Delete the DNS cache

Upload Firmware, Certificate or Configuration

On the Maintenance Page [\[28\]](#), select the required file with "Browse .." in the sections "Firmware Update", "SSL Certificate Upload" or "Config Import File Upload" and press "Upload". The file is now transferred to the update area of the device and the contents are checked. Only now, pressing the "Apply" button will permanently update the data, or abort with "Cancel".

 Only one upload function can be initiated with a reboot, e.g. you cannot transmit firmware and configuration at the same time.

 If after a firmware update, the web page is not displayed correctly anymore, this may be related to the interaction of Javascript with an outdated browser cache. If a Ctrl-F5 does not help, it is recommended that you manually delete the cache in the browser options. Alternatively, you can test start the browser in "private mode".

 During a firmware update, old data formats are sometimes converted to new structures. If an older firmware is newly installed, the configuration data and the energy meters may be lost! If the device then does not run correctly, please restore the factory settings (e.g. from the Maintenance Page [\[28\]](#)).

Actions in Bootloader mode

If the web interface of the device is no longer accessible, the device can be put into Bootloader mode (see chapter Bootloader activation [\[30\]](#)). The following functions can be executed using the GBL_Conf.exe application:

- Set IPv4 address, net-mask and gateway
- Turn HTTP password on and off
- Turn IP-ACL on and off
- Factory Reset
- Allow jump from firmware to bootloader
- Restart the device

 For devices with relays, entering or exiting the bootloader mode does not change the state of the relays as long as the operating voltage is maintained.

The GBL_Conf.exe program is available free of charge on our website www.gude-systems.com.

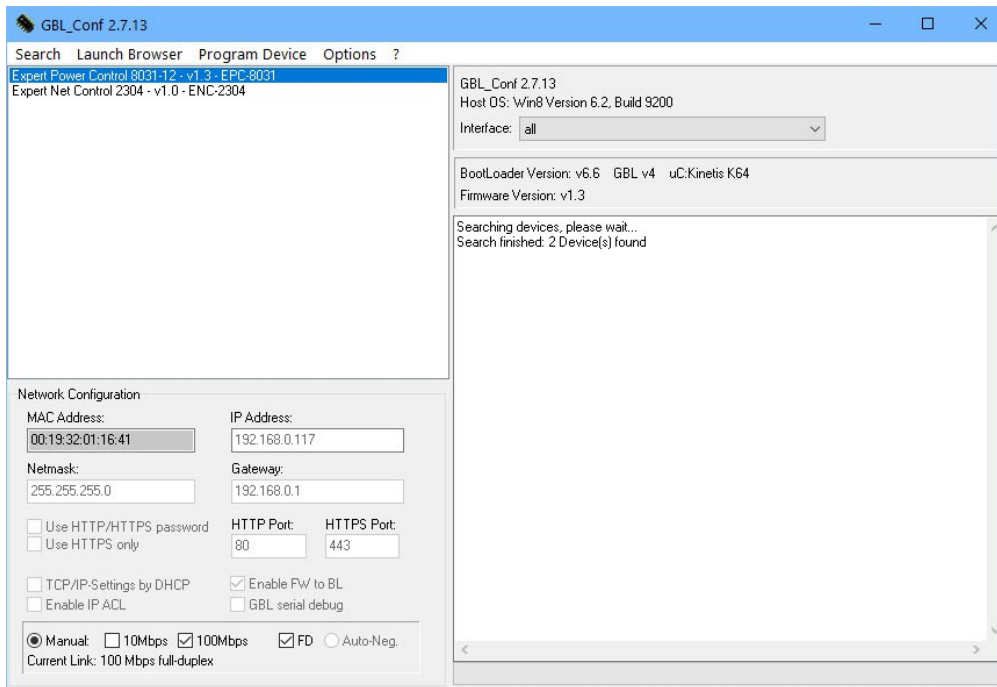

Interface GBL_Conf

To check the network settings with GBL_Conf.exe, start the program and choose "All Devices" in the "Search" menu. From the list select the appropriate device. The lower part of the left half of the window now shows the current network settings of the device. If the IP address is displayed with the default settings (192.168.0.2), either no DHCP server is present on the network, or there could be no free IP address assigned to it.

- Activate the Bootloader Mode (see Chapter Bootloader Mode) and choose in menu "Search" the item "Bootloader-Mode Devices only"
- Enter the desired settings in the edit window and save them with "Save Config".
- Deactivate the boot loader mode for the changes to take effect. Select again "All Devices" in the "Search" menu of GBL_Conf.exe.

The new network configuration is now displayed.

 Changing the configuration with gbl_conf.exe is explicitly only allowed in boot-loader mode!

Factory Reset

The device can be reset to the factory default via the web interface from the Maintenance Page^[28] or from the Bootloader mode (see chapter Bootloader activation^[30]). All TCP/IP settings are reset in this operation.

 If a unit is set to factory defaults, an uploaded certificate or updated firmware will be preserved.

2.3.1 Maintenance Page

This section provides access to important functions such as Firmware Update or Re-start Device. It is advisable to set an HTTP password for this reason.

Firmware Update
Please use R2 firmware uploads only.

Certificate Upload

Config Import File Upload

[Config File Export](#)

Restart / Fab-Settings

All these operations will leave the state of the Power Ports untouched!

Service Data

- Config/Status View: [status.html](#)
- Config/Status Download: [export.json](#)

Firmware Update: Start a firmware update.

Certificate Upload: Saves certificates. Your own SSL certificate for the web server or 802.1X certificates can be saved. See the "SSL ¹⁰⁴" chapter for generating a certificate in the correct format.

Config Import File Upload: Loads a new configuration from a text file. To apply the new configuration, a "Restart Device" must be executed after the "Upload".

Config File Export: Saves the current configuration in a text file.

 Saving the configuration should only be carried out in an SSL connection, since it contains sensitive password information (even if it is encrypted or hashed).

Restart Device: Restarts the device without changing the status of the relays.

 Some functions such as a firmware update or changing of the IP-address and HTTP settings require a restart of the device. A jump to the boot loader or a restart of the device lead by no means to a change of the relay states.

Restore Fab Settings and Restart Device: Performs a restart and resets the device to

factory default 

Enter Bootloader Mode: Jumps into bootloader mode, where additional settings can be made with GBL_Conf.exe.

Flush DNS Cache: All entries in the DNS cache are discarded and address resolutions are requested again.

Config/Status View: status.html: Displays the status.html page with the JSON data.

Config/Status Download: export.json: Direct file download of JSON data from status.html.

2.3.2 Configuration Management

The device configuration can be saved and restored in the maintenance area .

Config Import File Upload

[Config File Export](#)

The "Config File Export" function can be used to save the current configuration as a text file. The syntax used in the configuration file corresponds to the commands of the Telnet console. If the configuration of a device is to be restored from a text file, load the file with "Upload" and restart the device with "Restart Device".

 Saving the configuration should only be carried out in an SSL connection, since it contains sensitive password information (even if it is encrypted or hashed). For the same reasons, it is advisable to carefully handle the generated configuration files when archiving.

Editing the configuration file

It is possible to customize a saved configuration file with a text editor for your own needs. For example, one scenario would be to use a script language to automate the creation of many customized versions of a configuration, then equip a large number of devices with an individualized configuration. Also Upload and restart with CGI commands can be done in scripting languages. With use of the comment sign "#" you can quickly hide single commands or add personal notes.

If you modify a configuration file manually, it is not always clear which limits are allowed for parameters. After uploading and restarting, commands with invalid parameters are ignored. Therefore, the generated configuration includes comments describing the boundaries of the parameters. Where "range:" refers to a numeric value, and "len:" to a text parameter. E.g:

```
email auth set 0 #range: 0..2
email user set "" #len: 0..100
```

The command "system fabsettings" from the beginning of a generated configuration file brings the device into the factory state, and then executes the individual commands that modify the configuration state. It may be desirable to make the changes relative to the current configuration, and not out of the factory state. Then the "system fabsettings" should be removed.

No output of default values

The configuration file contains (with exceptions) only values which differ from the default. The command "system fabsettings" (go to the factory state) from the beginning of a generated configuration file should not be removed, otherwise the device can get incompletely configured.

Configuration via Telnet

The configuration files can in principle also be transferred in a Telnet session, but then the settings are changed during operation, and not completely when restarting, as it would have been the case with an upload. It can happen that events are triggered at the same time as the device is configured. One should therefore:

- a) disable the function
- b) completely parametrize
- c) reactivate the function

An example:

```
email enabled set 0
email sender set "" #len: 0..100
email recipient set "" #len: 0..100
email server set "" #len: 0..100
email port set 25
email security set 0 #range: 0..2
email auth set 0 #range: 0..2
email user set "" #len: 0..100
email passwd hash set "" #len: 0..100
email enabled set 1 #range: 0..1
```

2.3.3 Bootloader Activation

The configuration of the device from the application "GBL_Conf.exe" is only possible, if the device is in Bootloader Mode.

Activation of the Bootloader Mode

1) via push button:

- Hold both buttons for 3 seconds

2) or

- Remove the power supply
- Hold down the "Select" button. If the push button is recessed, use a pin or paper clip
- Connect the operating voltage

3) by Software:

- Start the "GBL_Conf.exe" program
- Do a network search with the "Search" menu action
- Activate in menu "Program Device" the item "Enter Bootloader"

 This function is only possible if "Enable FW to BL" was activated in the application "GBL_Conf.exe" before, while the device was already in the bootloader.

4) via web interface:

Press "Enter Bootloader Mode" on the maintenance  web page.

Whether the device is in Bootloader mode, is indicated by the flashing of the status LED, or it is shown in "GBL_Conf.exe" application after a renewed device search (appendix "BOOT-LDR" after the device name). In Bootloader mode the program "GBL_Conf.exe" can disable the password and the IP ACL, perform a firmware update, and restore the factory settings.

 For devices with relays, entering or exiting the bootloader mode does not change the state of the relays as long as the operating voltage is maintained.

Abandonment of the Bootloader Mode

1) via push button:

- Hold both buttons for 3 seconds (only if the device has 2 buttons)

2) or

- Remove and connect the power supply without operating a button

3) by Software:

- Start the "GBL_Conf.exe" application
- Do a network search with the "Search" menu action
- In menu "Program Device" activate the item "Enter Firmware"

 For devices with relays, entering or exiting the bootloader mode does not change the state of the relays as long as the operating voltage is maintained.

Factory Reset

If the device is in bootloader mode, it can always be put back to its factory default. All TCP/IP settings are reset in this operation.

 If a unit is set to factory defaults, an uploaded certificate or updated firmware will be preserved.

1) via push button:

- Activate the Bootloader Mode of the device
- Hold down the button (or the "Select" button for devices with 2 buttons) for 6 seconds. If the push button is recessed, use a pin or paper clip
- The status LED will blink in a fast rhythm, please wait until the LED blinks slowly (about 5 seconds)

2) by Software:

- Activate the Bootloader Mode of the device
- "Start the GBL_Conf.exe" program
- In menu "Program Device" activate the item "Reset to Fab Settings"
- The status LED will blink in a fast rhythm, please wait until the LED blinks slowly

(about 5 seconds)

Configuration

3 Configuration

TCP/IP configuration by DHCP

After switching on the device is scanning on the Ethernet for a DHCP server and requests an unused IP address. Check the IP address that has been assigned and adjust if necessary, that the same IP address is used at each restart. To turn off DHCP use the software GBL_Conf.exe or use the configuration via the web interface.

To check the network settings with GBL_Conf.exe, start the program and choose "All Devices" in the "Search" menu. From the list select the appropriate device. The lower part of the left half of the window now shows the current network settings of the device. If the IP address is displayed with the default settings (192.168.0.2), either no DHCP server is present on the network, or there could be no free IP address assigned to it.

3.1 Power Ports

Power Ports

Choose Power Port to configure: A1: Power Port

Label: Power Port

Coldstart status: on off remember last state

Coldstart delay: 0 s

Repower delay ⓘ: 0 s

Reset action duration ⓘ: 10 s

Enable watchdog: yes no

Configuration - "All Off" order

Order of port switching for "All Off" Command: Low to high Reverse order

Choose Power Port to configure: This field is used to select the power ports to be configured.

Label: You can assign a name up to 15 characters for each of the power ports. Using the name, an identification of the the device connected to the port can be facilitated.

Start-up Monitoring

It is important, that if necessary the condition of the power ports can be restored after a power failure. Therefore each port can be configured with Initialization status to a specific start-up state. This start-up sequence can be carried out delayed by the parameter Initialization Delay. There is in any case a minimum one-second delay between switching of ports.

Coldstart status: This is the port state (on, off, remember last state) the port should be set when the device is turned on. The setting "remember last state" saves the last manually set state of the power port in the EEPROM.

Configuration

Coldstart delay: Here can be configured how long the port should wait to switch to its defined state after the device is turned on. The delay may last up to 8191 seconds. This corresponds to a period of approx. two hours and 20 minutes. A value of zero means that the initialization is off.

Repower delay: When this feature is enabled (value greater than 0), the power port will switch itself on again a specified time after it has been disabled. Unlike the "Reset" button this function applies to all switch actions, including SNMP, or an optional serial interface.

Reset action duration: When the "Reset" button is triggered, the device turns the power port off, waits for the time entered here (in seconds) and turns the power port on.

Enable watchdog: Activates the watchdog function for this power port.

Order of port switching for "All Off" Command: Determines the order in which ports are switched on, in ascending order (Low to high) or in reverse order.



In older firmware versions, the "All Off" command was executed in ascending order.

Configuration - Powerbanks

Powersource Bank A: DC 5V (S1)

Powersource Bank B: DC 12V (S2) DC 24V (S5)

Powersource Bank C: DC 12V (S3) DC 24V (S5)

Powersource Bank D: DC 12V (S4) DC 24V (S5)

Powersource Bank E: AC (L1)

Configuration - Voltage Boost

Powersource Bank A: 5.0V 5.1V 5.3V 5.5V

Powersource Bank B: 12.0V 12.2V

Powersource Bank C: 12.0V 12.2V

Powersource Bank D: 12.0V 12.2V

Configuration - Powerbanks

Powersource Bank X: For banks B to D, you can choose between 12V and 24V. Bank A and Bank E have a fixed voltage.

Configuration - Voltage Boost

Powersource Bank X: For banks A to D, it is possible to increase the output voltage slightly. The voltage then remains closer to the desired value even under load conditions.

3.1.1 Watchdog

The watchdog feature enables to monitor various remote devices. Therefore either ICMP pings or TCP pings are sent to the device to be monitored. If these pings are not answered within a certain time (both the time and the number of attempts can be set), the port is reset. This allows e.g. to automatically restart not responding server or NAS systems. The mode IP master-slave port allows you to switch a port depending on the availability of a remote device.

Configuration

When a watchdog is activated it presents various information in the Control Panel. The information is color-coded.

- Green text: The watchdog is active and regularly receives ping replies.
- Orange text: The watchdog is currently enabled, and waits for the first ping response.
- Red text: The watchdog is active and receives no ping replies anymore from the configured IP address.

After the watchdog has been enabled, the display remains orange until the watchdog receives a ping response for the first time. Only then the watchdog is activated. Even after triggering a watchdog and a subsequent power port reset, the display will remain orange until the device is rebooted and responds again to ping requests. This will prevent a premature watchdog reset of the port, e.g. when a server needs a long time for a file check.

You can monitor devices on your own network, as well as devices on an external network, e.g. the operating status of a router.

Enable watchdog: yes no
Ping type: ICMP TCP
Hostname:
Ping interval: s
Ping retries:
Watchdog mode: Reset port when host down:
 Infinite wait for booting host after reset
 Repeat reset on booting host after ping timeouts
 Switch off once when host down
 IP Master-Slave port:
 host comes up -> switch on, host goes down -> switch off
 host goes down -> switch on, host comes up -> switch off
 Report Event only (don't switch port)
 count PING requests as unreplied when ethernet link down

Enable watchdog: Enables the watchdog function for this Power Port.

Watchdog type: Here you can choose between the monitoring by ICMP pings or TCP pings.

- ICMP Pings: The classic ping (ICMP echo request). It can be used to check the accessibility of network devices (for example, a server).
- TCP Pings: With TCP pings, you can check if a TCP port on the target device would accept a TCP connect. Therefore a non-blocked TCP port should be selected. A good choice would be port 80 for http or port 25 for SMTP.

TCP port: Enter the TCP port to be monitored. When using ICMP pings this is not needed.

Hostname: The name or IP address of the monitored network device.

Ping interval: Select the frequency (in seconds) at which the ping packet is sent to each network device to check its operating status.

Ping retries: After this number of consecutive unanswered ping requests the device is considered inactive.

Watchdog mode: When Reset port when host down is enabled, the Power Port is turned off and switched back on after the time set in Reset Duration. In mode Switch off once when host down the Power Port remains disabled.

At the default setting (Infinite wait for booting host after reset) the watchdog monitors the connected device. When there is no longer a reply after a set time, the watchdog performs the specified action, usually a reset of the Power Port. Now the watchdog waits until the monitored device reports again on the network. This may take several minutes depending on the boot duration of the device. Only when the device is accessible from network again, the watchdog is re-armed. If the option Repeat reset on booting host after x ping timeout is enabled, this mechanism is bypassed. Now the watchdog is re-activated after N ping intervals (input field ping timeouts).

When enabling the IP master-slave mode, the port is switched depending on the availability of a remote device. Depending on the configuration, the port is switched on when the terminal is reachable, or vice versa.

The Report Event only (don't switch port) mode monitors the IP address and sends messages accordingly, without switching.

 The option Repeat reset on booting host after x ping timeout has the following pitfall: If a server, that is connected to the monitored port is in need for a long boot process (e.g. it is doing a file system check), the server would probably exceed the tripping time of the watchdog. The server would be switched off and on again, and the file system check is restarted. This would be repeated endlessly.

count PING requests as unreplied when ethernet link down: If the Ethernet link of the device is not active, watchdog monitoring is not possible and the watchdog function is not activated. If this option is activated, a watchdog is also triggered if the Ethernet link is down.

3.2 Ethernet

3.2.1 IP Address

[IP Address](#) · [IP ACL](#) · [HTTP Server](#)

Hostname
Hostname:

IPv4
Use IPv4 DHCP: yes no
IPv4 Address:
IPv4 Netmask:
IPv4 Gateway address:
IPv4 DNS address:
MAC address: 00:19:32:01:a8:24

IPv6
Use IPv6 Protocol: yes no
Use IPv6 Router Advertisement: yes no
Use DHCP v6: yes no
Use manual IPv6 address settings: yes no

Hostname: Here you can enter a name with up to 63 characters. This name will be used for registration on the DHCP server.

 Special characters and umlauts can cause problems in the network.

IPv4 Address: The IP address of the device.

IPv4 Netmask: The network mask used in the network.

IPv4 Gateway address: The IP address of the gateway.

IPv4 DNS address: The IP address of the DNS server.

Use IPv4 DHCP: With "yes" the TCP/IP settings are obtained directly from the DHCP server. When the function is selected, each time the device powers up it is checked if a DHCP server is available on the network.

 If no DHCP server is available, the last IP address is used. However, the DHCP client tries to reach a DHCP server again every 5 minutes. The DHCP request lasts one minute until it is aborted. During this time the IP-address is not accessible! It is therefore essential to deactivate DHCP for a static IP addresses!

Use IPv6 Protocol: Activates IPv6 usage.

Use IPv6 Router Advertisement: The Router Advertisement communicates with the router to make global IPv6 addresses available.

Use DHCP v6: Requests from an existing DHCPv6 server addresses of the configured DNS server.

Use manual IPv6 address settings: Activates the entry of manual IPv6 addresses.

Configuration

IPv6 status: Displays the IPv6 addresses over which the device can be accessed, and additionally DNS and router addresses.

IPv6 status

Current IPv6 status:

IPv6 Addr:	fe80::219:32ff:fe00:996d 2007:7dd0:ffc1:l:219:32ff:fe00:996d
IPv6 DNS Server:	2007:7dd0:ffc1:1:20c:29ff:feaf:93c
IPv6 Router:	fe80::20c:29ff:feaf:93c

 For IP changes a firmware reset is required. This can be done in the Maintenance web page. A restart of the device leads by no means to a change of the relay states.

Manual IPv6 Configuration

IPv6 (manual)

IPv6 Addresses:	<input type="text" value="2007:7dd0:ffc1:0:219:32ff:fe00:996d"/>	/ 64
	<input type="text"/>	/ 64
	<input type="text"/>	/ 64
	<input type="text"/>	/ 64
IPv6 DNS addresses:	<input type="text" value="2007:7dd0:ffc1:0:20c:29fffeaf:93c"/>	
	<input type="text"/>	
IPv6 Gateway address:	<input type="text" value="fe80::20c:29ff:feaf:93c"/>	

The input fields for the manual setting of IPv6 addresses allow you to configure the prefix of four additional IPv6 device addresses, and to set two DNS addresses, and a gateway.

PHY Setting

PHY preferences can be set for 10 Mbps or 100 Mbps, half-duplex or full-duplex. Advertising means that a proposal for the connection is made, which can be rejected by the remote terminal (e.g. the switch).

PHY Settings

Actual Speed: 100 Mbps
Actual Duplex Mode: Full Duplex

Change Settings (Advertising):

3.2.2 IP ACL

ICMP Ping
Reply ICMP ping requests: yes no

IP Access Control List
Enable IP filter: yes no

1. Grant IP access to host/net:	<input type="text" value="1234::4ef0:eecl:0:219:32ff:fe00:f124"/>	-	+
2. Grant IP access to host/net:	<input type="text" value="192.168.1.84"/>	-	+
3. Grant IP access to host/net:	<input type="text" value="mypc.locdom"/>	-	+
4. Grant IP access to host/net:	<input type="text" value="192.168.1.0/24"/>	-	+
5. Grant IP access to host/net:	<input type="text" value="1234:4ef0:eecl:0::/64"/>	-	+

Reply ICMP ping requests: If you enable this feature, the device responds to ICMP pings from the network.

Enable IP filter: Enable or disable the IP filter here. The IP filter represents an access control for incoming IP packets.

 Please note that when IP access control is enabled HTTP and SNMP only work if the appropriate servers and clients are registered in the IP access control list.

 If you choose a wrong IP ACL setting and locked yourself out, please activate the Bootloader Mode and use GBL_Conf.exe to deactivate the IP ACL. Alternatively, you can reset the device to factory default.

3.2.3 HTTP

HTTP

HTTP Server option: HTTP + HTTPS
 HTTP redirects to HTTPS
 HTTPS only HTTP only

Server port HTTP:
Server port HTTPS:
Supported TLS versions:

HTTP Password

Enable password protection: yes no
Use radius server passwords: yes no
Use locally stored passwords: yes no

Set new **admin** password: (32 characters max)
Repeat **admin** password:

Set new **user** password: (32 characters max)
Repeat **user** password:

Session Timeout (admin): (seconds)
Session Timeout (user): (seconds)
Select Authentication Mode:

HTTP Server option: Selects whether access is possible only with HTTP, HTTPS, or both.

Server port HTTP: Here can be set the port number of the internal HTTP. Possible values are from 1 to 65534 (default: 80). If you do not use the default port, you must append the port number to the address with a colon to address the device from a web browser. Such as: "http://192.168.0.2:800"

Server port HTTPS: The port number to connect the web server via the SSL (TLS) protocol.

Supported TLS versions: Limits the supported TLS versions.

Enable Ajax autorefresh: If this is activated, the information of the status page is automatically updated via http request (AJAX).

 For some HTTP configuration changes a firmware reset is required. This can be done in the Maintenance web page. A restart of the device leads by no means to a change of the relay states.

Enable password protection: Password access protection can be activated. If the admin password is assigned, you can only log in by entering this password to change settings. Users can log in by entering the user password in order to query the status information and initiate switching operations.

Use radius server passwords: Username and password are validated by a Radius

Sever.

Use locally stored passwords: Username and password are stored locally. In this case, an admin password and a user password must be assigned. The password can have a maximum of 31 characters. The name "admin" and "user" are provided for the user name in the password entry mask of the browser. No passwords are set in the factory settings.

 If the password mask is redisplayed, only four "bullets" are shown as a symbolic placeholder, since for security reasons the device never stores the password itself, but only the SHA2-256 hash. If you want to change a password, the complete password must always be re-entered.

 If you have forgotten your password, please activate the bootloader mode and then turn off the password prompt in GBL_Conf.exe.

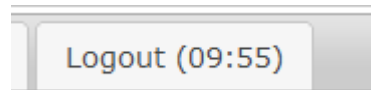

If a password is activated, the web session is automatically terminated after a timeout and you are redirected to the login page. A timeout of "0" disables the automatic logout.

Session Timeout (admin): Logout time for the admin.

Session Timeout (user): Logout time for the user.

Select Authentication Mode: Sets the session authentication mode. For details see [HTTP Authentication](#).

3.2.4 802.1X

802.1X

Enable 802.1X: yes no

Select EAP:

Device Name: (64 char. max)

Set new password: (64 char. max)

Repeat password:

Supported TLS versions:

Validate 802.1X Root CA:

Fallback to non 802.1X after 2min inactivity:

Enable 802.1X: Activates 802.1X port authentication.

Select EAP: Specifies the desired EAP authentication protocol.

Device Name: Name to be validated.

Set new Password: Sets password for certain EAP authentication protocols.

Supported TLS versions: Restricts the supported TLS versions.

Validate 802.1X Root CA: Checks the validity of the 802.1X server certificate using a saved root CA.

Fallback to non 802.1X after 2min inactivity: If no 802.1X protocol activity is detected on the switch within 2 minutes, 802.1X switches itself off until the next Ethernet link change.

3.3 Protocols

3.3.1 Console

[Console](#) · [Syslog](#) · [SNMP](#) · [Radius](#) · [Modbus](#) · [MQTT](#)

TCP/IP Console

Enable Telnet: yes no
Telnet TCP port:
Raw mode: yes no
Active negotiation: yes no
Activate echo: yes no
Push messages: yes no
Delay after 3 failed logins: yes no

Enable SSH: yes no
SSH TCP port:
Activate echo: yes no
Push messages: yes no

Require user login (Telnet/SSH): yes no
Use radius server passwords: yes no
Use locally stored passwords: yes no
Username:
Set new password: (32 characters max)
Repeat password:
Upload new SSH public key:

Telnet

Enable Telnet: Enables the Telnet console.

Telnet TCP port: Telnet sessions are accepted on this port.

Raw mode: The VT100 editing and the IAC protocol are disabled.

Active negotiation: The IAC negotiation is initiated by the server.

Configuration

Activate echo: The Telnet echo setting if not changed by IAC.

Push messages: Sends push messages via SSH.

Delay after 3 failed logins: After 3 wrong entries of username or password, the next login attempt is delayed.

SSH

Enable SSH: Enables the SSH protocol.

SSH TCP port: Port on which SSH sessions are accepted.

Activate echo: The echo setting for SSH.

Push messages: Sends push messages via SSH.

SSH and Telnet

Require user login: Username and password are required.

Use radius server passwords: Username and password are validated by a Radius Sever.

Use locally stored passwords: Username and password are stored locally.

Upload SSH public key: Input field for public key.

Delete public key: Setting this at Apply deletes the public key.

Serial console
Enable serial console: yes no
Raw mode: yes no
Activate echo: yes no
Enable binary KVM protocol: yes no
Enable UTF-8 support: yes no
Push messages: yes no
Require user login: yes no
Delay after 3 failed logins: yes no
Use radius server passwords: yes no
Use locally stored passwords: yes no
Username:
Set new password: (32 characters max)
Repeat password:

Enable serial console: Enables the serial console.

Raw mode: The VT100 editing is disabled.

Activate echo: The echo setting.

Enable binary KVM protocol: Additionally activates the KVM protocol.

Enable UTF8 support: Enables character encoding in UTF8.

Push messages: Sends push messages via serial console.

Require user login: Username and password are required.

Delay after 3 failed logins: After 3 wrong entries of username or password, the next login attempt is delayed.

Use radius server passwords: Username and password are validated by a Radius Sever.

Use locally stored passwords: Username and password are stored locally.

3.3.2 Syslog

[Console](#) · [Syslog](#) · [SNMP](#) · [Radius](#) · [Modbus](#) · [MQTT](#)

Syslog

Enable Syslog: yes no

Syslog server:

Enable Syslog: Enables the usage of Syslog Messages.

Syslog Server: If you have enabled Syslog Messages, enter the IP address of the server to which the syslog information should be transmitted.

3.3.3 SNMP

SNMP

Enable SNMP options: SNMP get SNMP set

SNMP UDP port:

sysContact:

sysName:

sysLocation:

SNMP v2

Enable SNMP v2: yes no

SNMP v2 public Community: (16 char. max)

SNMP v2 private Community: (16 char. max)

SNMP v3

Enable SNMP v3: yes no

SNMP v3 Username: (32 char. max)

SNMP v3 Authorization Algorithm:

Set new **Authorization** password: (8 char. min, 32 char. max)

Repeat **Authorization** password:

SNMP v3 Privacy Algorithm:

Set new **Privacy** password: (8 char. min, 32 char. max)

Repeat **Privacy** password:

SNMP Traps

Send SNMP Traps:

SNMP trap receiver 1 :

SNMP-get: Enables the acceptance of SNMP-GET commands.

SNMP-set: Allows the reception of SNMP-SET commands.

SNMP UDP Port: Sets the UDP port where SNMP messages are received.

sysContact: Value of RFC 1213 sysContact.

sysName: Value of RFC 1213 sysName.

sysLocation: Value of RFC 1213 sysLocation.

Enable SNMP v2: Activates SNMP v2.

 Because of security issues, it is advisable to use only SNMP v3, and to disable SNMP v2. Accesses to SNMP v2 are always insecure.

Community public: The community password for SNMP GET requests.

Community private: The community password for SNMP SET requests.

Enable SNMP v3: Activates SNMP v3.

SNMP v3 Username: The SNMP v3 User Name.

SNMP v3 Authorization Algorithm: The selected Authentication Algorithm.

SNMP v3 Privacy Algorithm: SNMP v3 Encryption Algorithm..

 If the password mask is redisplayed, only four "bullets" are shown as a symbolic placeholder, since for security reasons the device never stores the password itself, but only the key formed using the Authorization Algorithm. If you want to change a password, the complete password must always be re-entered.

 The calculation of the password hashes varies with the selected algorithms. If the Authentication or Privacy algorithms are changed, the passwords must be re-entered in the configuration dialog. "SHA-384" and "SHA512" are calculated purely in software. If "SHA-512" is set on the configuration page, the time for the key generation may take once up to approx. 45 seconds.

Send SNMP traps: Here you can specify whether, and in what format the device should send SNMP traps.

SNMP trap receiver: You can insert here up to eight SNMP trap receiver.

MIB table: The download link to the text file with the MIB table for the device.

More information about SNMP settings are available from our support.

3.3.4 Radius

[Console](#) · [Syslog](#) · [SNMP](#) · [Radius](#) · [Modbus](#) · [MQTT](#)

Radius

Enable Radius Client: yes no

Authentication Protocol: PAP CHAP

Use Message Authentication: yes no

Default Session Timeout:

Primary Server:

Set new shared secret:

Repeat new shared secret:

Timeout:

Retries:

Use backup server: yes no

Backup Server:

Set new shared secret:

Repeat new shared secret:

Timeout:

Retries:

Enable Radius Client: Enables validation over Radius.

Use CHAP: Use CHAP password encoding.

Configuration

Use Message Authentication: Adds the "Message Authentication" attribute to the Authentication Request.

Primary Server: Name or IP address of the Primary Radius server.

Shared secret: Radius Shared Secret. For compatibility reasons, only use ASCII characters.

Timeout: How long (in seconds) will be waited for a response from an Authentication Request.

Retries: How often an authentication request is repeated after a timeout.

Use Backup Server: Activates a Radius Backup server.

Backup Server: Name or IP address of the Radius Backup server.

Shared secret: Radius Shared Secret. For compatibility reasons, only use ASCII characters.

Timeout: How long (in seconds) will be waited for a response from an Authentication Request.

Retries: How often an authentication request is repeated after a timeout.

Test Radius Server

Test Username:

Test Password:

Test Username: Username input field for Radius test.

Test Password: Password input field for Radius test.

The "Test Radius Server" function allows you to check whether a combination of Username and Password is accepted by the configured Radius Servers.

3.3.5 Modbus TCP

[Console](#) · [Syslog](#) · [SNMP](#) · [Radius](#) · [Modbus](#) · [MQTT](#)

Modbus TCP

Enable Modbus TCP: yes no

Modbus TCP port:

Configuration

Enable Modbus TCP: Enables Modbus TCP support.

Modbus TCP port: The TCP/IP port number for Modbus TCP.

3.3.6 MQTT

MQTT

Enable MQTT: yes no

Broker:

TLS: yes no

TCP Port: (Default: 8883)

Username:

Set new password:

Repeat password:

Client ID:

Quality of Service (QoS): ▾

Keep-alive ping interval: s (minimum 10s)

Topic Prefix:
de/gudesystems/epc/00:19:32:01:16:41

Permit CLI commands: yes no

Publish device data summary interval: s (0=disabled)

Enable MQTT: Enables MQTT support.

Broker: DNS or IP address of the MQTT broker.

TLS: Turns on TLS encryption.

TCP port: The TCP/IP port number of the broker.

Username: The MQTT username.

Password: The password for the username.

Client ID: The MQTT client ID.

 The client IDs of a user must be different! If two clients of a user have the same name, the connection of one client is normally terminated.

Quality of Service (QoS): Sets the QoS value (0 or 1) of the MQTT publishes.

Keep-alive ping interval: This defines the time interval in which the client sends an MQTT ping.

Topic prefix: Defines the beginning of the topic with which all messages are sent. The strings **[mac]** and **[host]** symbolize the MAC address or the hostname of the device.

Permit CLI commands: Enables the execution of console commands.

Publish device data summary interval: Time interval in which messages with the global status of the device are sent.

MQTT Logs

- MQTT client connected
- MQTT sending client id:'client_1641' username:'epc-user'
- MQTT broker connected
- MQTT broker DNS resolved
- MQTT broker DNS not yet resolved
- MQTT resolving host 'f3c06b76137c48439e81c18b11bd06ab.s1.eu.hivemq.cloud' TCP port 8883

MQTT Broker Status

- Broker DNS ready, connected since 71 seconds
- Last publish 11 seconds ago

MQTT Logs: Outputs individual log messages about the connection setup.

MQTT Broker Status: Time information about connection duration, the last publish and the last keep-alive.

3.4 Clock

3.4.1 NTP

[NTP](#) · [Timer](#)

NTP

Enable Time Synchronization: yes no

Primary NTP server:

· reply 25s ago, 6ms signal delay
· Fri Aug 22 2025 09:31:55 GMT+0200 (Central European Summer Time)

Backup NTP server:

Timezone:

Timezone:

Daylight Saving Time (DST):

Clock

Current Systemtime (UTC): 07:32:21 22.08.2025 (1755847941)

Current Localtime: 09:32:21 22.08.2025

Browsertime: 09:32:22 22.08.2025

Set clock:

Enable Time Synchronization: Enables the NTP protocol.

Primary NTP server: IP address of the first NTP server.

Backup NTP server: IP address of the second NTP server. Used when the first NTP server does not respond.

Timezone: The set time zone for the local time.

Daylight Saving Time: Allows you to deactivate daylight saving time or set different

daylight saving time models (currently Europe or US/Canada).

set manually: The user can set a time manually.

set to Browstime: Sets the time corresponding to web browser.

 If Time synchronization is enabled, a manual time will be overwritten at the next NTP synchronization.

3.4.2 Timer

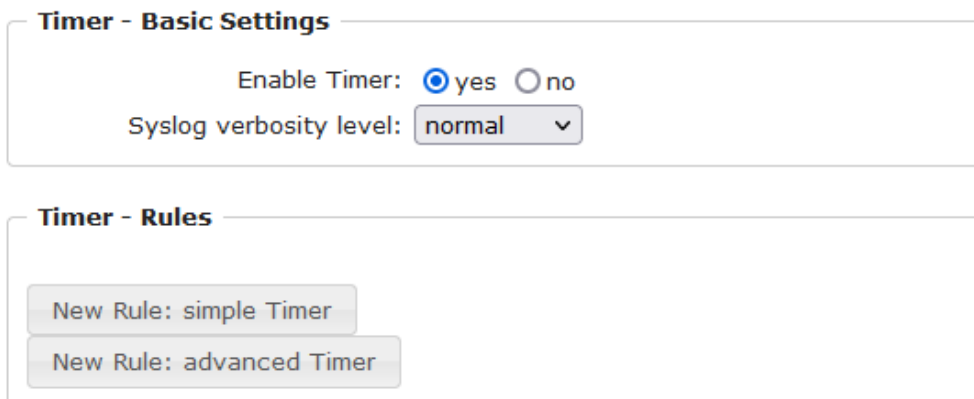

Timer - Basic Settings

Enable Timer: yes no

Syslog verbosity level: ▼

Timer - Rules

New Rule: simple Timer

New Rule: advanced Timer

Enable Timer: Enables or disables all timers globally.



Syslog verbosity level: Sets the verbosity level for timer syslog output.

New Rule simple Timer: Shows a dialog for a simple timer rule.

New Rule advanced Timer: Brings up the dialog for advanced timer settings.

3.4.3 Timer Configuration

In the timer configuration you have three options: Create a simple timer, add a complex timer, or change an existing configuration.

 Timer rules are only executed if the device has a valid time. See configuration NTP .

 The number of timers is limited to 32.

 This instruction chapter applies to all Gude devices. For devices without switchable ports you can only create a complex timer. For an action there is only the register "Action CLI" available, and not the register "Action PortSwitch".

Timer - Basic Settings

Enable Timer: yes no

Syslog verbosity level:

Timer - Rules

New Rule: simple Timer

New Rule: advanced Timer

Creating a simple timer

If you activate "New Rule: simple Timer" the following dialog is displayed:

Timer Rule

Switch

From : To :

On weekdays: Mon Tue Wed Thu Fri Sat Sun

You set here which port should be switched for which time period, and on which days of the week the rule is active. In this example the period 9:00 to 17:00 is changed to 9:30 to 11:00 compared to the default input mask. Also, this rule should not be applied on Saturday and Sunday. The rule we have now says that every day, except Saturday and Sunday, port 1 will be switched on at 9:30 and switched off after 1.5 hours. Clicking on "Save" saves this rule.

Timer - Rules

🕒 Rule 1: Port On

🕒 Rule 2: Port Off

New Rule: simple Timer

New Rule: advanced Timer

We have now created 2 rules, one for when the port is turned on and the second for when it is turned off.

Creating a complex timer

If you create a complex timer or change an existing timer, you will always see an extended dialog. Here, ports can be switched as well as other actions can be executed via CLI commands. The setting of the switching times is more granular.

Timer - Rule 1: Port On

Trigger: Date/Time Pattern Options Action PortSwitch Action Cli

Hours:
00 01 02 03 04 05 06 07 08 09 10 11 12 13 14 15 16 17 18 19 20 21 22 23

Minutes:
00 01 02 03 04 05 06 07 08 09 10 11 12 13 14 15 16 17 18 19 20 21 22 23 24 25 26 27 28 29
30 31 32 33 34 35 36 37 38 39 40 41 42 43 44 45 46 47 48 49 50 51 52 53 54 55 56 57 58 59

Days:
01 02 03 04 05 06 07 08 09 10 11 12 13 14 15 16 17 18 19 20 21 22 23 24 25 26 27 28 29 30 31

Month
01 02 03 04 05 06 07 08 09 10 11 12

Days of week:
Mon Tue Wed Thu Fri Sat Sun

Delete Save Cancel

You can see here the extended representation of the first rule of the simple timer from the previous example. The action is started every day of every month at 9:30. The weekdays Saturday and Sunday are excluded. An existing rule can be removed with the "Delete" button.

 If a rule is deleted, the following rules move up. The numbering of the following rules also changes by one. This also applies to the index in the console commands.

Timer - Rule 1: Port On

Trigger: Date/Time Pattern Options Action PortSwitch Action Cli

Rule Name: Port On

Rule Valid from: [] to [] dd.mm.yyyy

Random Trigger Probability: 100

Random Trigger Jitter: 0 secs

enable trigger: yes no

Action mode: Switch Power Ports Perform CLI Cmd

Delete Save Cancel

The button enable trigger allows to switch a timer on and off without the need to completely delete or recreate the rule. A simple timer is directly "enabled", for a newly created complex timer "enable trigger" must be switched on manually. You can set a probability and a jitter for the timer rules. This makes random events possible. In this example the rule is executed with 100% probability. A jitter of 0 means that the action takes place exactly at the programmed time. Ports are switched as action mode, alternatively a console command (CLI Cmd) can be executed.

 After changes to existing timers, the "Rule Name" may no longer be meaningful. To keep the overview, it may be useful to adjust the name.

The switching function can be set in more detail on the "Action PortSwitch" register. Port 1 is switched on. You could extend the rule and switch more ports on or off. Additionally you can set a time for a batchmode in the field after "Between Action1 and Action 2 : wait", which starts "Action 2" after expired time. However, the batch mode has the disadvantage that it is not automatically restarted when the device is rebooted. Also, the port is locked against manual operation on the web page as long as the batch mode is running.

 The "Action PortSwitch" function is only available for devices with switchable ports.

Extending a rule

For demonstration purposes, here is an extension to the simple timer from the previous example:

The action is now started not only at 9:30, but also at 17:30 There are other changes: The timer is only active between October and December, also the action does not take place on the first day of a month.

 Since all fields in the mask are always considered, it is not possible to define the times 9:30 and 17:10 in a single timer rule. You need a second rule for this. If you set the hours 9 and 17, as well as the minutes 10 and 30, then the four times 9:10, 9:30, 17:10 and 17:30 would be programmed.

Configuration

 To change a field in this input mask without changing the state of the other fields, the Ctrl key must be pressed during the mouse click.

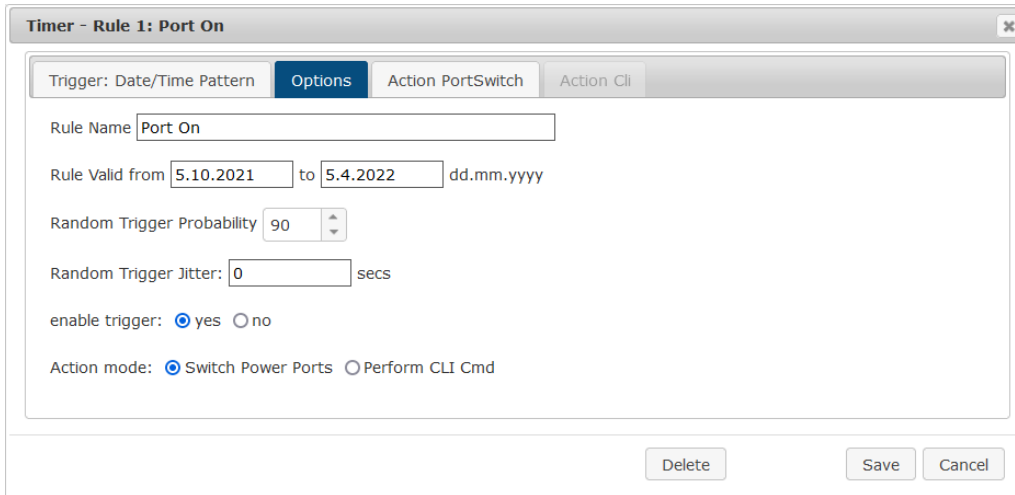

The screenshot shows the 'Options' tab of the 'Timer - Rule 1: Port On' configuration window. The 'Rule Name' is 'Port On'. The 'Rule Valid from' is '5.10.2021' and 'to' is '5.4.2022' in dd.mm.yyyy format. The 'Random Trigger Probability' is set to 90. The 'Random Trigger Jitter' is 0 seconds. The 'enable trigger' is set to 'yes'. The 'Action mode' is 'Switch Power Ports'.

For this rule, on the "Options" tab, the time period is limited to the range between 5.10.2021 and 5.4.2022. In this example, the timer rule is only executed with a probability (Random Trigger Probability) of 90%.

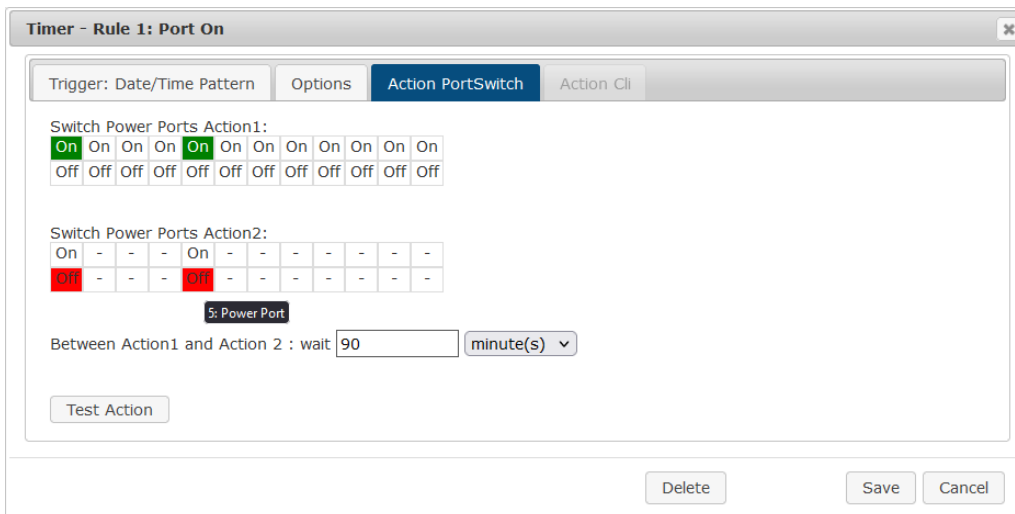

The screenshot shows the 'Action PortSwitch' tab of the 'Timer - Rule 1: Port On' configuration window. It displays two tables for 'Switch Power Ports Action1' and 'Switch Power Ports Action2'. Action1 has 10 ports, with port 5 highlighted in green and 'On'. Action2 has 10 ports, with port 5 highlighted in red and 'Off'. A tooltip '5: Power Port' is shown over the port 5 field. The 'Between Action1 and Action 2 : wait' is set to 90 minutes.

In this example, port 1 and port 5 are enabled and disabled after 90 minutes by batch mode.

 Action 2 is realized internally by a batch mode. This does not continue to run if a restart of the device has taken place in the meantime.

 A popup on the mouse pointer shows the port number of the field.

Console Commands

Configuration

Timer - Rule 1: Port On

Trigger: Date/Time Pattern Options Action PortSwitch **Action Cli**

Perform CLI Command:

```
port 1 reset
port 3 state set 1
```

31/64

Test Action

Delete Save Cancel

Instead of switching a port, one or more console commands can be executed. These commands are entered in the "Action CLI" register. The "Action Cli" tab can only be selected if the option "Perform CLI Cmd" is activated in "Options".

Example Switching a Port on a Date

If you want to switch on a timer on a certain date at a certain time and switch it off at a later time, you cannot do it directly with a simple timer. Therefore it can be useful to create the timer as a simple timer first, and then customize it in the advanced dialog.

Timer Rule

Switch 3: Power Port On

From 09:25 To 17:30

On weekdays: Mon Tue Wed Thu Fri Sat Sun

Save Cancel

Switch port 3 on every day at 9:25, and off again at 17:30. You save.

Timer - Rule 3: Port On

Trigger: Date/Time Pattern **Options** Action PortSwitch Action Cli

Rule Name Port On

Rule Valid from 24.10.2022 to 24.10.2022 dd.mm.yyyy

Random Trigger Probability 100

Random Trigger Jitter: 0 secs

enable trigger: yes no

Action mode: Switch Power Ports Perform CLI Cmd

Delete Save Cancel

Then call up the two timer rules you created ("On" and "Off") and enter the date on

which the switching operation is to take place in the "Options" tab.

Example blind control

Timer - Rule 3: Port On

Trigger: Date/Time Pattern **Options** Action PortSwitch Action Cli

Rule Name: Random Trigger Port 1

Rule Valid from: [] to [] dd.mm.yyyy

Random Trigger Probability: 100

Random Trigger Jitter: 1800 secs

enable trigger: yes no

Action mode: Switch Power Ports Perform CLI Cmd

Delete Save Cancel

You can use the jitter e.g. for a shutter control. In the classic example of a shutter control, you do not always want to raise and lower the shutters at the same time in order to confuse potential burglars. The jitter of 1800 seconds means that the action is executed randomly in a period between 30 minutes before and 30 minutes after the programmed time. The probability (Random Trigger Probability) of execution here is 100%.

3.5 Sensors

Sensors Config

Sensor: 1: 7210 - 7210

Sensor Name: 7210

Select Sensor Field: Temperature (°C)

Enable value-threshold message trigger: yes no

Maximum value: 65.0 °C

Minimum value: 25.0 °C

Hysteresis: 3.0 °C

Sensor: Selects a sensor type to configure it. The first digit "1:" indicates the number of the sensor port (only important for devices with more than one sensor port). This is followed by the sensor name, and the adjustable sensor name.

Sensor Name: Changeable name for this sensor. For example, you can give the temperature and the humidity a different name, even if they belong to the same sensor.

Select Sensor Field: Selects a data channel from a sensor.

Enable value-threshold message trigger: Enables monitoring of sensor threshold values.

Maximum/Minimum value: Adjustable threshold values at which messages should be

Configuration

sent via console (Telnet/SSH), SNMP trap, Syslog, MQTT or e-mail.

Hysteresis: Defines the distance that must be exceeded after a limit value of an external sensor has been exceeded in order to signal that the limit value has fallen below.

Define switching rules for trigger values

Port Names	Above Max	Below Max	Above Min	Below Min
A1 Power Port	Off	On	—	—
A2 Power Port	—	—	On	Off
A3 Power Port	—	—	—	—
A4 Power Port	—	—	—	—
A5 Power Port	—	—	—	—
B1 Power Port	—	—	—	—
B3 Power Port	—	—	—	—
D4 Power Port	—	—	—	—
E1 Power Port	—	—	—	—
E2 Power Port	—	—	—	—
E3 Power Port	—	—	—	—
E4 Power Port	—	—	—	—

Define switching rules for trigger values: Switches one or more ports depending on whether a limit value is exceeded or not reached.

Enable time-interval message trigger: yes no
 every second(s)
for Console- and MQTT channels

Enable value-delta message trigger: yes no
 every value step of °C
for Console- and MQTT channels

Message channels: Syslog SNMP Email Console
 MQTT:
 Beeper:
 Flashing display

Enable time interval message trigger: Generates console (Telnet/SSH) and MQTT messages within time intervals.

Enable value-delta message trigger: Generates console (Telnet/SSH) and MQTT messages when a sensor value deviates by a delta value.

Message channels: Enables the generation of messages on different channels.

For the beeper, you can choose between a continuous and an interrupted tone. Flashing display causes the 7-segment display to flash. Pressing a front panel button resets the beeper and the flashing display.

Misc sensor options

Min/Max measurement period: 24 Hours ▾

Allow beeper for AC alarms: yes no

Allow beeper for other alarms: yes no

Temperature unit: °C ▾

Pressure unit: hPa ▾

Min/Max measurement period: Selects the time range for the sensor min/max values on the overview web page.

Allow beeper for AC alarms: Switches on the buzzer for all messages when the electrical limits are exceeded or not reached. In addition, in [Message channels](#) can be configured for each sensor individually whether and which type of buzzer should be activated.

Allow beeper for other alarms: Switches on the beeper for all messages when the non-electrical sensor limits are exceeded. In addition, in [Message channels](#) can be configured for each sensor individually whether and which type of buzzer should be activated.

Temperature unit: The temperature is displayed in °C or °F.

Pressure unit: Display of air pressure in hPa or inHg.

 Changing the temperature or air pressure units does not change the size of the set limit values. These may still need to be adjusted for the new unit.

System Events

If you select "System" as [Sensor](#), it is possible to select the message channels for global events, such as switching a port.

Hysteresis Example:

A Hysteresis value prevents that too much messages are generated, when a sensor value is jittering around a sensor limit. The following example shows the behavior for a temperature sensor and a hysteresis value of "1". An upper limit of "50 °C" is set. Example:

49.9 °C - is below the upper limit

50.0 °C - a message is generated for reaching the upper limit

50.1 °C - is above the upper limit

...

49.1 °C - is below the upper limit, but in the hysteresis range

49.0 °C - is below the upper limit, but in the hysteresis range

48.9 °C - a message is generated for underrunning the upper limit inclusive hysteresis range

...

3.5.1 Port Switching

Depending on the measured Current and the measured sensor values, switching actions can be triggered. During operation, the actions configured for crossing the limits are executed. For example, when a value moves from the range "above max value" inside the range "below max value", the action defined for "below max value" is performed. In the case of device start, configuration or plug-in of the sensor, the actions

Configuration

corresponding to the range in which the current temperature is located are switched.

Example with "Maximum value" of 65 °C, "Minimum value" of 25 °C and hysteresis of 3 °C. The dotted line shows the hysteresis.

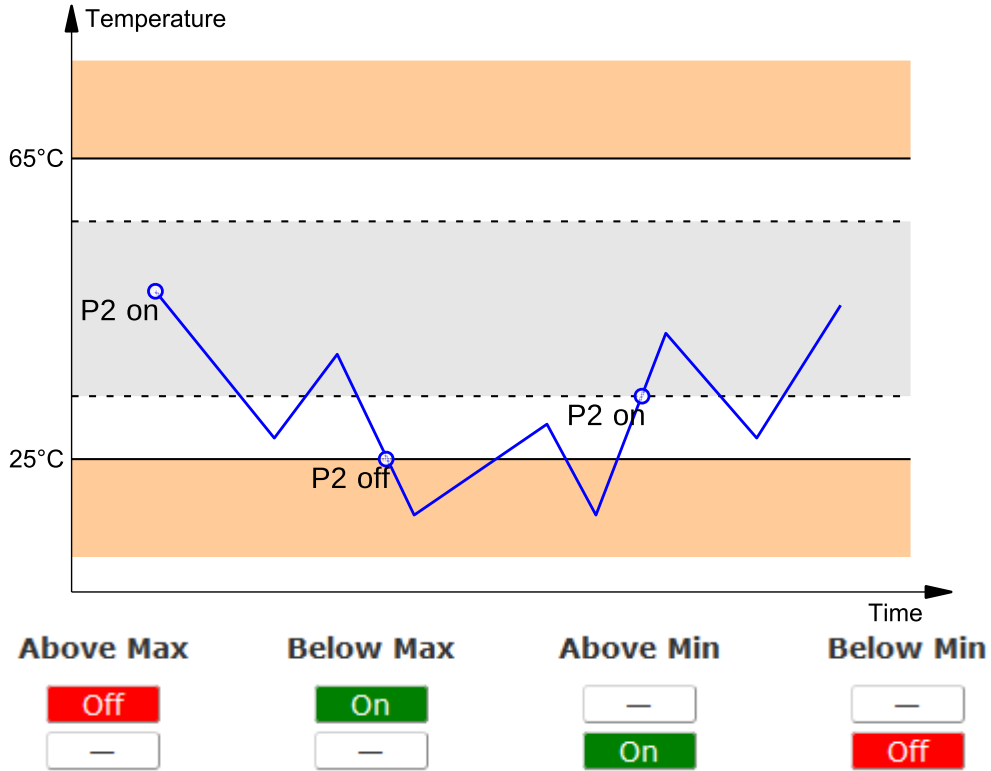

Actions during configuration, device start or plugging in the sensor (for given example):

actual temperature during configuration	actions
70 °C	Port A1 Off (above max) + Port A2 On (above min)
45 °C	Port A1 On (below max) + Port A2 On (above min)
20 °C	Port A1 On (below max) + Port A2 Off (below min)

Action matrix during operation when limit values are exceeded (for given example):

	to "above max"	to "below max"	to "above min"	to "below min"
from "above max"	-	A1 On	A1 On	A1 On + A2 Off
from "below max"	A1 Off	-	-	A2 Off
from "above min"	A1 Off	-	-	A2 Off
from "below min"	A1 Off + A2 On	A2 On	A2 On	-

⚠ Only the switching operations for which actions have been defined, are triggered. If no "On" or "Off" action is defined for a port, the port can never reach this state by exceeding sensor values. Unless it is the initial state.

3.6 E-Mail

E-Mail

Enable E-Mail: yes no

Sender address:

Recipient address:

SMTP server:

SMTP server port: (Default: 587)

SMTP Connection Security:

Authentication

SMTP Authentication (password):

Username:

Set new password:

Repeat password:

Enable E-Mail: Activates the E-Mail dispatch of messages.

Sender address: The E-Mail address of the sender.

Recipient address: The E-Mail address of the recipient. Additional E-Mail addresses, separated by comma, can be specified. The input limit is 100 characters.

SMTP Server: The SMTP IP-address of the E-Mail server. Either as FQDN, e.g: "mail.gmx.net", or as IP-address, e.g: "213.165.64.20". If required, attach a designated port, e.g: "mail.gmx.net:25".

SMTP server port: The port address of the E-Mail server. In the normal case this should be the same as the default, that is determined by the setting SMTP Connection Security.

SMTP Connection Security: Transmission via SSL or no encryption.

SMTP Authentication (password): Authentication method of the E-Mail Server.

Username: User name that is registered with the SMTP E-Mail server.

Set new password: Enter the password for the login to the E-Mail server.

Repeat password: Enter the password again to confirm it.

 If the password mask is redisplayed, only four "bullets" are shown as a symbolic placeholder, since for security reasons the password is never shown itself. If you want to change a password, the complete password must always be re-entered.

E-Mail Logs: Logging of E-Mail system messages.

3.7 Front Panel

Front Panel

Button Lock: yes no

Allow switching all ports: yes no

Display 1 default: Localtime HH:MM ▼

Display 2 default: L1: Meter1: Current ▼

Button Lock: Disables the front buttons (activates the key lock) with the exception of the bootloader activation.

Allow switching all ports: Allows to switch all ports on or off with the front panel buttons.

Display X default: Selects the display of sensor values for both displays.

3.8 Fan

Fan

Venting Fan Speed: automatic ▼

Venting Fan Speed: Switches the fan between a maximum or a temperature controlled fan speed.

Specifications

Specifications

4 Specifications

4.1 Automated Access

The device can be accessed automatically via four different interfaces, which offer different possibilities to access the configuration data and status information. Only http and the console (telnet and serial) provide full access to the device.

 This chapter is general for all Gude devices. Depending on the device model are ports, certain sensors or other features not available.

List of different access options:

Interface	Scope of Access
HTTP	read / write status of Power Ports (relays or eFuses) read / write all configuration data read / write all status information (full access to the device)
Console 65	read / write status of Power Ports (relays or eFuses) read / write all configuration data read / write all status information (full access to the device)
SNMP 99	read / write status of Power Ports (relays or eFuses) read / write names of Power Ports (relays or eFuses) read / write status of Port start configuration read / write status Buzzer read / write configuration of power sources (EPC 8291) read / write fan configuration (EPC 8291) read measurement values of external sensors read measurement values of all energy sensors read NTP time and status resetting the energy meters read the status of Overvoltage Protection
Modbus TCP 87	read / write status of Power Ports (relays or eFuses) read status of Inputs read / write configuration of power sources (EPC 8291) read / write fan configuration (EPC 8291) read measurement values of external sensors read measurement values of all energy sensors read the status of Overvoltage Protection
MQTT	Execute console commands

The device can be controlled via HTTP interface with CGI commands and returns the internal configuration and status in JSON format. The structure of the CGI commands and the JSON data is explained in more detail in our Wiki article: wiki.gude-systems.com/EPC_HTTP_Interface

4.2 802.1X Authentication

The device supports the following protocols for 802.1X port authentication on the switch:

- EAP-TLS

- EAP-PEAPv0
- EAP-TTLS PAP
- EAP-TTLS CHAP
- EAP-TTLS MSCAPv2

 The 802.1X port authentication is not available in the bootloader for resource reasons. When switching to the bootloader, 802.1X must not be active.

Setting up 802.1X

- a) Upload an 802.1X certificate in Maintenance.
- b) Optionally transfer an 802.1X root CA file.
- c) Activate the protocol in the Ethernet / 802.1X configuration and enter the corresponding parameters. Press Apply.
- d) The next time the Ethernet link is changed, 802.1X is started.

 A **device name** is usually not necessary for the EAP-TLS protocol. In this case, a "dummy name" such as *anonymous@example.com* can be entered.

 The size of the certificates is limited to 16384 bytes for resource reasons.

 Some EAP protocols such as EAP-PEAPv0 and EAP-TTLS can lead to incompatibilities with older RADIUS servers and TLS 1.3. If problems occur during authentication, restrict to TLS 1.2 as a test (configuration "TLS v1.2 only").

Fallback

If there is no 802.1X authentication with the connected switch after 2 minutes, 802.1X switches off until the next Ethernet link change. This enables the device to be addressed directly with a laptop, for example, in the event of an incorrect configuration. This fallback is configurable. If it is deactivated, access without valid 802.1X authentication is only possible after a change to the factory settings.

Status LED

If 802.1X is active, this is indicated by the status LED:

- Flashing: long orange - short off: 802.1X authentication active
- Flashing: long orange - short red: 802.1X authentication error occurred

4.3 Console

For the configuration and control of the device, there is a set of commands with parameters that can be entered through a console. The console is available via SSH or Telnet, or for devices with RS232 port through using a serial terminal. It is not necessary to use Telnet, in **Raw Mode** a simple TCP/IP connection is sufficient to send commands. The communication can also be performed automated (e.g. via scripting languages). The console features are configured through the web interface [\[43\]](#).

Login

A ssh / telnet log in can be configured with password or without:

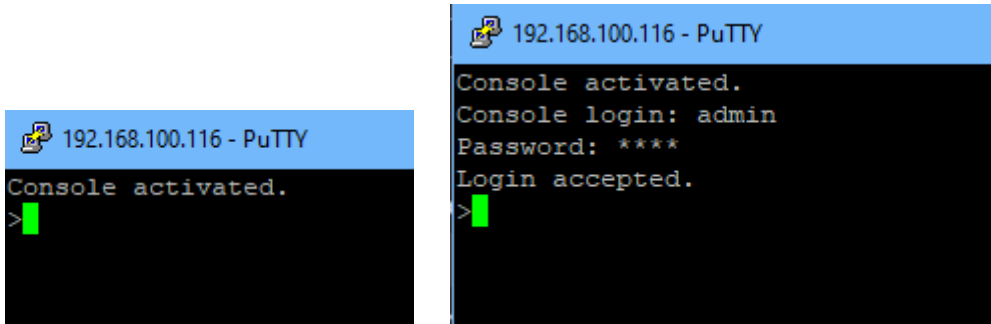

Command Set

There are several command levels. The following commands are usable from each level:

back	go back one level
help	all commands of the actual level
help all	show all commands
logout	logout (only when login required)
quit	quit console

The "help" command returns all the commands of the current level. If "help" is called from the top level, e.g. the line "http [subtopics]" appears. This means that there is another level for "http". With the command "http help" all commands below "http" are shown. Alternatively, with entering "http" you can select the http level, and "help" shows all the commands on the selected level. The command "back" again selects the top level. It is possible to use "help" at any position: "http passwd help" provides all commands that have the prefix "http passwd".

You will find a complete list of all possible device commands in the chapter "Cmd Overview".

Parameter

If parameters are expected for the command, the parameter may be passed as numeric or constant. If e.g. you get the following line as help:

```
http server set {http_both=0|https_only=1|http_only=2}
```

the following instruction pairs are equivalent:

```
http server set https_only  
http server set 1
```

or

```
http server set https_both  
http server set 0
```

Numerical parameters can be entered with different bases. Here is an example of the decimal value 11:

Base	Input
decimal (10)	11

hexadecimal (16)	0xb
octal (8)	013
binary (2)	0b1011

Bit Field Parameter

Some parameters can take several values at the same time. In the following example, all values between 0 and 5 can be set. In the help, this can be recognized by the fact that the values are not separated by the "|" character, but by commas.

```
"{EVT_SYSLOG=0,EVT_SNMP=1,EVT_EMAIL=2,EVT_SMS=3,EVT_GSMEMAIL=4,EVT_BEEPER=5}"
```

To set EVT_SYSLOG and EVT_EMAIL in a command, you can use the following syntax:

```
>extsensor 1 2 0 events type set "EVT_SYSLOG,EVT_EMAIL"  
OK.
```

or numeric

```
>extsensor 1 2 0 events type set "0,2"  
OK.
```

Additionally you can set all values with "ALLSET" or encode any bit pattern as hexadecimal with a syntax like "#7f1a".

Return Values

If a command is unknown or a parameter is incorrect, the output "ERR." is given at the beginning of the line, followed by a description of the fault. Successful instructions without special return value will be acknowledged by "OK.". All other return values are output within a single line. There are of two exceptions:

1. Some configuration changes, that affect TCP / IP and UDP, need a restart to be applied. These parameters are output on two lines. In the first line the current value is shown, on the second row the value after a restart. In the "Cmd Overview" table this is marked with "Note 2".
2. Other configurations (such as the assigned IPv6 addresses) have several values that can change dynamically. This is marked with "Note 3" in the "Cmd Overview" table.

Numerical Returns

For parameters that support constants, these constants are output as return values. To better deal with scripting languages, it may be easier to work only with numerical returns. The command "vt100 numeric set ON" enables that only numerical values appear.

Comments

If you use a tool to send an entire file of commands via Telnet, it is helpful, if you can place comments in there. Beginning with the comment character "#", the remaining contents of a line is ignored.

Telnet

Specifications

If the configuration "Raw Mode" is turned off, it is tried to negotiate the Telnet configuration between client and server using IAC commands. If this fails, the editing functions are not active, and the "Activate echo" option determines whether the characters sent to the Telnet server will be returned. Normally the client begins with the IAC negotiation. If this is not the case with the client, the device configuration "Active negotiation" should be turned on.

Raw Mode

If you want to use the console only automated, it may be advantageous to set the configuration "Raw mode" to "yes" and "Activate echo" to "no" to. Then there is no interfering interaction with the editor functions and there is no need to filter the sent characters to process the return values.

 If in the console "Raw mode" is activated but not in the used Telnet client, the IAC commands sent at the beginning can appear as interfering characters in the command line (partially invisible).

Editing

The following edit functions are available when the terminal supports VT100, and Raw Mode is deactivated. Entered characters are inserted at the cursor position.

Keys	Function
Left, Right	moves cursor left or right
Pos1, End	moves cursor to the beginning or end of line
Del	deletes character under the cursor
Backspace	deletes character left of cursor
Up, Down	shows input lines history
Tab, Ctrl-Tab	completes the word at cursor
Ctrl-C	clears the line

 This chapter is general for all Gude devices. Depending on the device type, ports or certain sensors may not be available.

Sensor Examples

a) External Sensors

```
>extsensor all show
E=1,L="7106",0="21.3°C",1="35.1%",3="1013hPa",4="5.2°C",5="16.0°C"
E=2,L="7102",0="21.2°C",1="35.4%",4="5.3°C",5="15.9°C"
```

The command lists one connected external sensor per line, and the individual measured values are separated by commas after the label name. The digit before the equal sign corresponds to the Index field in the External Sensor Table.

```
>extsensor 1 0 value show
```

Displays temperature of the sensor at Port 1

b) Line Sensors

 For devices with 230V input metering (Metered PDU).

```
>linesensor all "0,1,2,3,12" show
L=1,L="Power Port",0="13000Wh",1="0W",2="225V",3="0A",12="998218s"
L=2,L="Power Port",0="13000Wh",1="0W",2="223V",3="0A",12="996199s"
```

This command outputs all line sensor values in one line. A list of all fields (according to the energy sensor table) is transferred as parameter. In this example these are the fields Absolute Active Energy (0), Power Active (1), Voltage (2), Current (3) and Reset Time (12).

```
>linesensor 1 "0,1,2,3,12" show
>linesensor 1 1 show
```

These variants give the sensor values of the field list or of a sensor at Line-In 1.

 For devices with Overvoltage Protection, the "linesensor all" command also outputs the state of the protection ("OVP=x"). A "1" means ok, a "0" a failure of the protection.

c) Port Sensors

 For devices with 230V output metering (Outlet-Metered PDU).

```
>portsensor all "0,1,2,3,12" show
P=1,L="Power Port",0="13000Wh",1="0W",2="225V",3="0A",12="998218s"
P=2,L="Power Port",0="13000Wh",1="0W",2="225V",3="0A",12="996199s"
...
P=12,L="Power Port",0="13000Wh",1="0W",2="225V",3="0A",12="998218s"
```

This command outputs all port sensor values in one line. A list of all fields (according to the energy sensor table) is passed as parameter. In this example these are the fields Absolute Active Energy (0), Power Active (1), Voltage (2), Current (3) and Reset Time (12).

```
>portsensor 2 "0,1,2,3,12" show
>portsensor 2 1 show
```

These variants give the sensor values of the field list or a sensor to at Outlet Port 2.

 The following examples refer to Gude devices that have switchable ports.

d) Displaying Port Relays

```
>port all state 1 show
P1=ON,P2=OFF,P3=ON,P4=OFF,P5=OFF,P6=OFF,P7=OFF,P8=ON
```

The command "port all state {MODE0=0|MODE1=1|MODE2=2} show" returns the switching state of all relays in 3 possible formats.

e) Switching Port Relays

```
#port all state set "1,2,12" 1
OK.
```

The command syntax "port all state set "{port_list}" {OFF=0|ON=1}" sets a list of ports to ON=1 or OFF=0.

Specifications

4.3.1 SSH

The device supports SSH-2 connections with either public key authentication or user name and password. The "login" must be enabled for SSH. Users and passwords can be stored locally or retrieved via a radius server. If you want to use SSH in a terminal, Activate echo should be enabled.

Public Keys

The following public keys are accepted:

Key type	Length
RSA	2048, 4096
ECDSA	256, 384

Generation with PuTTYgen

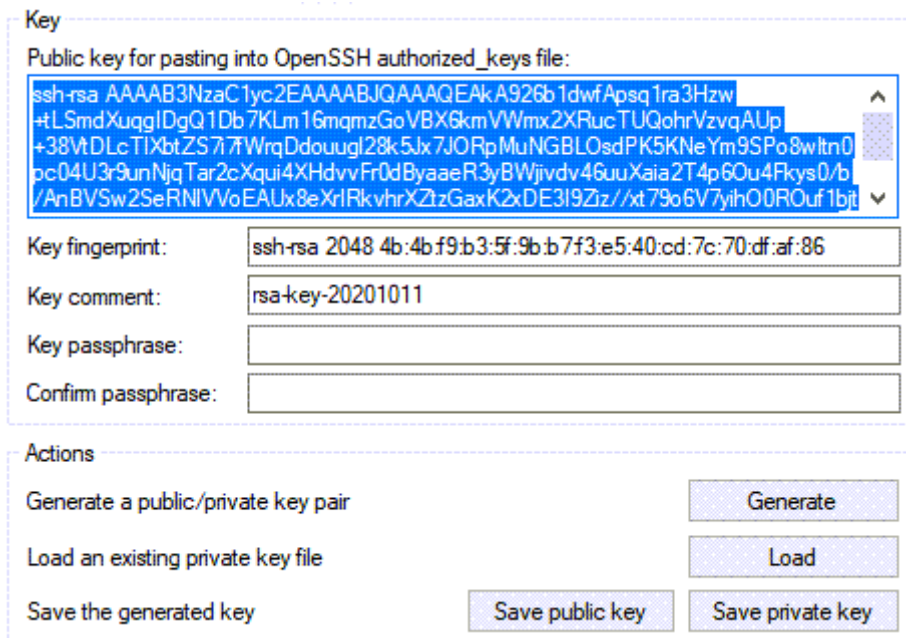

The screenshot shows the PuTTYgen 'Key' tab. A text area contains a public key for an RSA key pair. Below the text area are fields for 'Key fingerprint', 'Key comment', 'Key passphrase', and 'Confirm passphrase'. The 'Actions' section at the bottom includes buttons for 'Generate', 'Load', 'Save public key', and 'Save private key'.

Key

Public key for pasting into OpenSSH authorized_keys file:

```
ssh-rsa AAAAB3NzaC1yc2EAAAABJQAAQEAkA926b1dwfApsq1ra3Hzw  
+tLSmdXuqglDgQ1Db7Klm16mqmzGoVBX6kmVWmx2XRucTUQohrVzvqAUp  
+38VtDLcTIXbtZS77WrqDdougl28k5Jx7JORpMuNGBLOsdPK5KNeYm9SPo8wltmD  
pc04U3r9unNjqTar2cXqui4XHdvvFrDdByaaeR3yBWjivdv46uuXajia2T4p6Ou4Fkys0/b  
/AnBVSw2SeRNIVoEAUx8eXrIRkvhrXZizGaxK2xDE3l9Ziz/xt79o6V7yihO0ROuf1bjt
```

Key fingerprint: ssh-rsa 2048 4b:4b:f9:b3:5f:9b:b7:f3:e5:40:cd:7c:70:df:af:86

Key comment: rsa-key-20201011

Key passphrase:

Confirm passphrase:

Actions

Generate a public/private key pair

Load an existing private key file

Save the generated key

Generated keys can be copied directly from e.g. PuTTYgen,

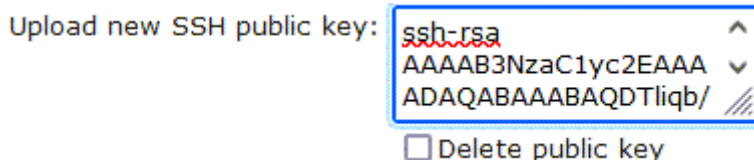

The screenshot shows a 'Upload new SSH public key' interface. A dropdown menu is open, showing the selected key type 'ssh-rsa' and the key content. Below the dropdown is a checkbox labeled 'Delete public key'.

Upload new SSH public key: ssh-rsa
AAAAB3NzaC1yc2EAAA
ADAQABAAABAQDTliqb/

Delete public key

and inserted into the Configuration - Console input field. Public keys are accepted in SSH2 or OpenSSH format.

Generation with ssh-keygen

The tool ssh-keygen is mostly shipped with Linux and Windows to generate SSH keys. Here is an example to generate an ECDSA 384 key.

```
ssh-keygen -t ecdsa -b 384 -f ssh.key
```

Specifications

In the file ssh.pub is then the private key, the content of ssh.key.pub is inserted into the field "Upload SSH public key:".

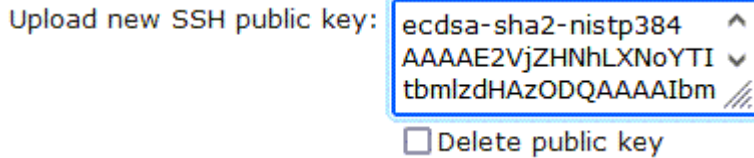

4.3.2 Console Cmd 8291-2

Command	Description	Note
logout	go to login prompt when enabled	2
quit	quits telnet session - nothing in serial console	2
back	back one cmd level	2
help	show all cmds from this level	2
help all	show all cmds	2
bank	enters cmd group "bank"	
bank {bank_num} powersrc set {powersrc_num}	sets power src of bank	
bank {bank_num} powersrc show	shows power src of bank	
bank powersrc all "{field_list}" show	shows power src energy sensors of field list for all banks	
bank powersrc {powersrc_num} "{field_list}" show	shows power src energy sensors of field list for given bank	
bank all "{field_list}" show	shows bank energy sensors of field list for all banks	
bank {bank_num} "{field_list}" value show	shows bank energy sensors of field list for given bank	
bank {bank_num} boost set <num>	sets voltage boost for efuse 5V({5V=0 5.1V=1 5.2V=2 5.3V=3}) or 12V({12V=0 12.6V=1})	
bank {bank_num} boost show	shows efuse voltage boost	
bank {bank_num} {energy_sens} events set {OFF=0 ON=1}	enables sensor events on/off	
bank {bank_num} {energy_sens} events show	shows if sensor events are enabled	
bank {bank_num} {energy_sens} events type set "{EVT_SYSLOG=0,EVT_SNMP=1,EVT_EMAIL=2,EVT_SMS=3,EVT_GSMEMAIL=4,EVT_BEEPER=5,EVT_DISPLAY=6,EVT_CONSOLE=7}"	enables different event types	
bank {bank_num} {energy_sens} events type show	shows what event types are enabled	
bank {bank_num} {energy_sens} events beeper mode set {CONTINUOUS=0 INTERMITTENT=1}	sets beeper tone	
bank {bank_num} {energy_sens} events beeper mode show	shows beeper tone	
bank {bank_num} {energy_sens} maxval set {float}	sets maximum value for sensor	
bank {bank_num} {energy_sens} maxval show	shows maximum value for sensor	
bank {bank_num} {energy_sens} hyst set {float}	sets hysteresis value for sensor	
bank {bank_num} {energy_sens} hyst show	shows hysteresis value for sensor	
bank {bank_num} {energy_sens} publish mode set {NONE=0 INTERVAL=1 DELTA=2 INTERV_DELTA=3}	sets publish mode	
bank {bank_num} {energy_sens} publish mode show	shows publish mode	
bank {bank_num} {energy_sens} publish mqtt retain set {OFF=0 ON=1}	sets mqtt retain	
bank {bank_num} {energy_sens} publish mqtt retain show	shows if mqtt retain set	
bank {bank_num} {energy_sens} publish timer set {num_secs}	sets publish time interval	
bank {bank_num} {energy_sens} publish timer show	shows publish time interval	
bank {bank_num} {energy_sens} publish delta set {float}	sets publish delta value	
bank {bank_num} {energy_sens} publish delta show	shows publish delta value	
bank {bank_num} {energy_sens} {BELOWMIN=0 ABOVEMIN=1 ABOVEMAX=2 BELOWMAX=3} port list set "{port_list}"	set Ports for Port Switching actions	

Specifications

bank {bank_num} {energy_sens} {BELOWMIN=0|
 ABOVEMIN=1|ABOVEMAX=2|BELOWMAX=3} show Port list for Port Switching actions
 port list show

clock	enters cmd group "clock"
clock ntp enabled set {OFF=0 ON=1}	enables ntp
clock ntp enabled show	shows if ntp enabled
clock timezone set {minutes}	sets timezone
clock timezone show	shows timezone
clock dst enabled set {OFF=0 ON=1}	enables dst
clock dst enabled show	shows if dst is enabled
clock manual set "{hh:mm:ss yyyy-mm-dd}"	sets time and date manually
clock show	shows actual time and date
clock ntp server {PRIMARY=0 BACKUP=1} set "{dns_name}"	sets ntp server name
clock ntp server {PRIMARY=0 BACKUP=1} show	shows ntp server name
console	enters cmd group "console"
console version	shows unique console version number
console telnet enabled set {OFF=0 ON=1}	enables telnet on/off
console telnet enabled show	shows if telnet enabled
console telnet port set {ip_port}	sets telnet port
console telnet port show	shows telnet port
console telnet raw set {OFF=0 ON=1}	sets raw mode (disables editing) on/off
console telnet raw show	shows if raw mode enabled
console telnet echo set {OFF=0 ON=1}	enables echo on/off
console telnet echo show	shows if echo enabled
console telnet activeneg set {OFF=0 ON=1}	enables telnet active negotiation (IAC) on/off
console telnet activeneg show	shows if active negotiation enabled
console telnet login set {OFF=0 ON=1}	enables login on/off
console telnet login show	shows if login enabled
console telnet login local set {OFF=0 ON=1}	enables local login on/off
console telnet login local show	shows if local login enabled
console telnet login radius set {OFF=0 ON=1}	enables login for RADIUS on/off
console telnet login radius show	shows if RADIUS login enabled
console telnet login delay set {OFF=0 ON=1}	enables delay (after 3 login fails) on/off
console telnet login delay show	shows if login delay enabled
console telnet pushmsgs config set {OFF=0 ON=1}	enables persistent push msgs
console telnet pushmsgs config show	shows if persistent push msgs are enabled
console telnet pushmsgs set {OFF=0 ON=1}	enables temporary push msgs
console telnet pushmsgs show	shows if temporary push msgs are enabled
console telnet user set "{username}"	sets login user name
console telnet user show	shows login user name
console telnet passwd set "{passwd}"	sets login password
console telnet passwd hash set "{passwd}"	sets login hashed password
console ssh enabled set {OFF=0 ON=1}	enables SSH
console ssh enabled show	shows if SSH enabled
console ssh port set {ip_port}	sets SSH port
console ssh port show	shows SSH port
console ssh echo set {OFF=0 ON=1}	enables echo on/off
console ssh echo show	shows if echo enabled
console ssh pushmsgs config set {OFF=0 ON=1}	enables persistent push msgs
console ssh pushmsgs config show	shows if persistent push msgs are enabled
console ssh pushmsgs set {OFF=0 ON=1}	enables temporary push msgs
console ssh pushmsgs show	shows if temporary push msgs are enabled
console ssh public hash set "{passwd}"	sets hash of SSH public key
console ssh public hash show	shows hash of SSH public key
console serial enabled set {OFF=0 ON=1}	enables serial console on/off
console serial enabled show	shows if serial console enabled
console serial raw set {OFF=0 ON=1}	sets raw mode (disables editing) on/off
console serial raw show	shows if raw mode enabled
console serial echo set {OFF=0 ON=1}	enables echo on/off
console serial echo show	shows if echo enabled
console serial kvm set {OFF=0 ON=1}	enables binary KVM cmds on serial port on/off
console serial kvm show	shows if binary KVM cmds enabled
console serial utf8 set {OFF=0 ON=1}	enables UTF8 support
console serial utf8 show	shows if UTF8 enabled
console serial login set {OFF=0 ON=1}	enables login on/off
console serial login show	shows if login enabled
console serial login local set {OFF=0 ON=1}	enables local login on/off
console serial login local show	shows if local login enabled
console serial login radius set {OFF=0 ON=1}	enables login for RADIUS on/off
console serial login radius show	shows if RADIUS login enabled
console serial login delay set {OFF=0 ON=1}	enables delay (after 3 login fails) on/off
console serial login delay show	shows if login delay enabled
console serial pushmsgs config set {OFF=0	enables persistent push msgs

Specifications

ON=1}	
console serial pushmsgs config show	shows if persistent push msgs are enabled
console serial pushmsgs set {OFF=0 ON=1}	enables temporary push msgs
console serial pushmsgs show	shows if temporary push msgs are enabled
console serial user set "{username}"	sets login user name
console serial user show	shows login user name
console serial passwd set "{passwd}"	sets login password
console serial passwd hash set "{passwd}"	sets login hashed password
email	enters cmd group "email"
email enabled set {OFF=0 ON=1}	enables email on/off
email enabled show	shows if email is enabled
email sender set "{email_addr}"	sets email sender address
email sender show	shows email sender address
email recipient set "{email_addr}"	sets email recipient address
email recipient show	shows email recipient address
email server set "{dns_name}"	sets email SMTP server address
email server show	shows email SMTP server address
email port set {ip_port}	sets email SMTP port
email port show	shows email SMTP port
email security set {NONE=0 STARTTLS=1 SSL=2}	sets SMTP connection security
email security show	shows SMTP connection security
email auth set {NONE=0 PLAIN=1 LOGIN=2}	sets email authentication
email auth show	show email authentication
email user set "{username}"	sets SMTP username
email user show	shows SMTP username
email passwd set "{passwd}"	sets SMTP password
email passwd hash set "{passwd}"	sets crypted SMTP password
email testmail	send test email
ethernet	enters cmd group "ethernet"
ethernet mac show	shows MAC address
ethernet link show	shows ethernet link state
ethernet phyprefer set {10MBIT_HD=0 10MBIT_FD=1 100MBIT_HD=2 100MBIT_FD=3}	sets preferred speed for PHY Auto Negotiation
ethernet phyprefer show	shows preferred speed for PHY Auto Negotiation
extinput	enters cmd group "extinput"
extinput {port_num} {inp_num} state show	shows input state
extinput all state {MODE0=0 MODE1=1 MODE2=2} show	shows input state of all ports in 3 different view modes
extinput {port_num} {inp_num} counter show	shows input change counter
extinput {port_num} {inp_num} name set "{name}"	sets sensor name to label
extinput {port_num} {inp_num} name show	shows label of sensor
extinput {port_num} {inp_num} invert enabled set {OFF=0 ON=1}	inverts input on/off
extinput {port_num} {inp_num} invert enabled show	shows if input inverted
extinput {port_num} {inp_num} label {LOW=0 HIGH=1} set "{name}"	sets input low/high text
extinput {port_num} {inp_num} label {LOW=0 HIGH=1} show	shows input low/high text
extinput {port_num} {inp_num} events set {OFF=0 ON=1}	enables input events on/off
extinput {port_num} {inp_num} events show	shows if input events are enabled
extinput {port_num} {inp_num} events type set "{EVT_SYSLOG=0,EVT_SNMP=1,EVT_EMAIL=2,EVT_BEEPER=5,EVT_DISPLAY=6,EVT_CONSOLE=7,EVT_MQTT=8}"	enables different event types
extinput {port_num} {inp_num} events type show	shows what event types are enabled
extinput {port_num} {inp_num} publish mode set {NONE=0 INTERVAL=1 DELTA=2 INTERV_DELTA=3}	sets publish mode
extinput {port_num} {inp_num} publish mode show	shows publish mode
extinput {port_num} {inp_num} publish mqtt retain set {OFF=0 ON=1}	sets mqtt retain
extinput {port_num} {inp_num} publish mqtt retain show	shows if mqtt retain set
extinput {port_num} {inp_num} publish timer set {num_secs}	sets publish time interval
extinput {port_num} {inp_num} publish timer show	shows publish time interval
extinput {port_num} {inp_num} {LOW=0 HIGH=1}	set Ports for Port Switching actions
port list set "{port_list}"	
extinput {port_num} {inp_num} {LOW=0 HIGH=1}	show Port list for Port Switching actions
port list show	
extsensor	enters cmd group "extsensor"

Specifications

extsensor all show	shows all values from connected external sensors	
extsensor all show	shows all plugged sensors and fields	
extsensor {port_num} {sen_field} value show	shows sensor value	6
extsensor {port_num} {sen_field} minval show	shows actual minimum value of the sensor	
extsensor {port_num} {sen_field} maxval show	shows actual maximum value of the sensor	
extsensor {port_num} {sen_field} reset	resets minimum and maximum value of the sensor	
extsensor {port_num} {sen_type} label set "{name}"	sets sensor name to label	6
extsensor {port_num} {sen_type} label show	shows label of sensor	6
extsensor {port_num} type show	shows type of sensor	
extsensor {port_num} {sen_type} {sen_field} events set {off=0 on=1}	enables sensor events on/off	6
extsensor {port_num} {sen_type} {sen_field} events show	shows if sensor events are enabled	6
extsensor {port_num} {sen_type} {sen_field} events type set "{EVT_SYSLOG=0,EVT_SNMP=1,EVT_EMAIL=2 ,EVT_SMS=3,EVT_GSMEMAIL=4,EVT_BEEPER =5,EVT_DISPLAY=6,EVT_CONSOLE=7,EVT_M QTT=8}"	enables different event types	6
extsensor {port_num} {sen_type} {sen_field} events type show	shows what event types are enabled	6
extsensor {port_num} {sen_type} {sen_field} events beeper mode set {CONTINUOUS=0 INTERMITTENT=1}	sets beeper tone	
extsensor {port_num} {sen_type} {sen_field} events beeper mode show	shows beeper tone	
extsensor {port_num} {sen_type} {sen_field} maxval set {num}	sets maximum value of sensor event	6
extsensor {port_num} {sen_type} {sen_field} maxval show	shows maximum value of sensor event	6
extsensor {port_num} {sen_type} {sen_field} minval set {num}	sets minimum value of sensor event	6
extsensor {port_num} {sen_type} {sen_field} minval show	shows minimum value of sensor event	6
extsensor {port_num} {sen_type} {sen_field} hyst set {num}	sets hysteresis value of sensor event	6
extsensor {port_num} {sen_type} {sen_field} hyst show	shows hysteresis value of sensor event	6
extsensor {port_num} {sen_type} {sen_field} publish mode set {NONE=0 INTERVAL=1 DELTA=2 INTERV_DELTA=3}	sets publish mode	
extsensor {port_num} {sen_type} {sen_field} publish mode show	shows publish mode	
extsensor {port_num} {sen_type} {sen_field} publish mqtt retain set {OFF=0 ON=1}	sets mqtt retain	
extsensor {port_num} {sen_type} {sen_field} publish mqtt retain show	shows if mqtt retain set	
extsensor {port_num} {sen_type} {sen_field} publish timer set {num_secs}	sets publish time interval	
extsensor {port_num} {sen_type} {sen_field} publish timer show	shows publish time interval	
extsensor {port_num} {sen_type} {sen_field} publish delta set {float}	sets publish delta value	
extsensor {port_num} {sen_type} {sen_field} publish delta show	shows publish delta value	
extsensor {port_num} {sen_type} {sen_field} {BELOWMIN=0 ABOVEMIN=1 ABOVEMAX=2 BELOWMAX=3} port list set "{port_list}"	set Ports for Port Switching actions	6
extsensor {port_num} {sen_type} {sen_field} {BELOWMIN=0 ABOVEMIN=1 ABOVEMAX=2 BELOWMAX=3} port list show	show Port list for Port Switching actions	6
extsensor period set {24H=0 12H=1 2H=2 1H=3 30MIN=4}	sets sensor Min/Max measurement period	
extsensor period show	shows sensor Min/Max measurement period	
extsensor beeper set {OFF=0 ON=1}	enables beeper sensor alarms	
extsensor beeper show	shows if beeper sensor alarms are enabled	
extsensor {port_num} {sen_field} calib set {float}	sets calibration offset for temperature or humidity	
extsensor {port_num} {sen_field} calib show	shows calibration offset for temperature or humidity	
http	enters cmd group "http"	
http server set {HTTP_BOTH=0 HTTPS_ONLY=1 HTTP_ONLY=2 HTTPS_REDIR=3}	sets accepted connection types	
http server show	shows accepted connection types	
http port set {ip_port}	sets http port	
http port show	shows http port	

Specifications

http portssl set {ip_port}	sets https port	
http portssl show	shows https port	
http tls mode set {TLS12=0 TLS13_12=1 TLS13=2 TLS13_12_11=3}	restricts TLS mode	
http tls mode show	shows TLS mode restriction	
http auth mode set {BASIC=0 SESSION=1 SESSION_EXT=2}	sets http session authentication mode	
http auth mode show	shows http session authentication mode and compatibility	
http passwd enabled set {OFF=0 ON=1}	enables http password on/off	
http timeout admin set {num_secs}	sets admin session timeout	
http timeout admin show	shows admin session timeout	
http timeout user set {num_secs}	sets user session timeout	
http timeout user show	shows user session timeout	
http passwd enabled show	shows if http password enabled	
http passwd local set {OFF=0 ON=1}	enables local login on/off	
http passwd local show	shows if local login enabled	
http passwd radius set {OFF=0 ON=1}	enables login for RADIUS on/off	
http passwd radius show	shows if RADIUS login enabled	
http passwd user set "{passwd}"	sets http user password	
http passwd admin set "{passwd}"	sets http admin password	
http passwd hash user set "{passwd}"	sets hashed http user password	
http passwd hash admin set "{passwd}"	sets hashed http admin password	
ip4	enters cmd group "ip4"	
ip4 hostname set "{name}"	sets device hostname	
ip4 hostname show	shows device hostname	3
ip4 address set "{ip_address}"	sets IPv4 address	
ip4 address show	shows IPv4 address	3
ip4 netmask set "{ip_address}"	sets IPv4 netmask	
ip4 netmask show	shows IPv4 netmask	3
ip4 gateway set "{ip_address}"	sets IPv4 gateway address	
ip4 gateway show	shows IPv4 gateway address	3
ip4 dns set "{ip_address}"	sets IPv4 DNS server address	
ip4 dns show	shows IPv4 DNS server address	3
ip4 dhcp enabled set {OFF=0 ON=1}	enables IPv4 DHCP on/off	
ip4 dhcp enabled show	shows IPv4 DHCP state	3
ip6	enters cmd group "ip6"	
ip6 enabled set {OFF=0 ON=1}	enables IPv6 on/off	
ip6 enabled show	shows if IPv6 is enabled	3
ip6 routadv enabled set {OFF=0 ON=1}	enables IPv6 router advertisement	
ip6 routadv enabled show	shows IPv6 router advertisement state	3
ip6 dhcp enabled set {OFF=0 ON=1}	enables IPv6 DHCP on/off	
ip6 dhcp enabled show	shows if IPv6 DHCP is enabled	3
ip6 address show	show all IPv6 addresses	4
ip6 gateway show	show all IPv6 gateways	4
ip6 dns show	show all IPv6 DNS server	4
ip6 manual enabled set {OFF=0 ON=1}	enables manual IPv6 addresses	
ip6 manual enabled show	shows if manual IPv6 addresses are enabled	3
ip6 manual address {1..4} set "{ip_address}"	sets manual IPv6 address	
ip6 manual address {1..4} show	shows manual IPv6 address	3
ip6 manual gateway set "{ip_address}"	sets manual IPv6 gateway address	
ip6 manual gateway show	shows manual IPv6 gateway address	3
ip6 manual dns {1..2} set "{ip_address}"	sets manual IPv6 DNS server address	
ip6 manual dns {1..2} show	shows manual IPv6 DNS server address	3
ipacl	enters cmd group "ipacl"	
ipacl ping enabled set {OFF=0 ON=1}	enables ICMP ping on/off	
ipacl ping enabled show	shows if ICMP ping enabled	
ipacl enabled set {OFF=0 ON=1}	enable IP filter on/off	
ipacl enabled show	shows if IP filter enabled	
ipacl filter {ipacl_num} set "{dns_name}"	sets IP filter {ipacl_num}	
ipacl filter {ipacl_num} show	shows IP filter {ipacl_num}	
linesensor	enters cmd group "linesensor"	
linesensor all {field_list} show	shows energy sensors according field list of all line sensors	5
linesensor {line_num} {field_list} show	shows energy sensors according field list of one line sensor	5
linesensor {line_num} {energy_sens} value show	shows energy sensor of given line	5
linesensor {line_num} ovp show	show state of Overvoltage Protection	
linesensor {line_num} counter reset	resets energy metering counter	
linesensor {line_num} label set "{name}"	sets line meter to label	
linesensor {line_num} label show	shows label of line meter	
linesensor {line_num} {energy_sens} events set {OFF=0 ON=1}	enables events on/off	

Specifications

linesensor {line_num} {energy_sens} events show	shows if events are enabled	
linesensor {line_num} {energy_sens} events type set	"{EVT_SYSLOG=0,EVT_SNMP=1,EVT_EMAIL=2 enables different event types ,EVT_SMS=3,EVT_GSMEMAIL=4,EVT_BEEPER=5}"	
linesensor {line_num} {energy_sens} events type show	shows what event types are enabled	
linesensor {line_num} {energy_sens} events beeper mode set {CONTINUOUS=0 INTERMITTENT=1}	sets beeper tone	
linesensor {line_num} {energy_sens} events beeper mode show	shows beeper tone	
linesensor {line_num} {energy_sens} maxval set {float}	sets maximum value for line meter	
linesensor {line_num} {energy_sens} maxval show	shows maximum value for line meter	
linesensor {line_num} {energy_sens} maxval set {float}	sets maximum value for line meter	
linesensor {line_num} {energy_sens} maxval show	shows maximum value for line meter	
linesensor {line_num} {energy_sens} minval set {float}	sets minimum value for line meter	
linesensor {line_num} {energy_sens} minval show	shows minimum value for line meter	
linesensor {line_num} {energy_sens} hyst set {float}	sets hysteresis value for line meter	
linesensor {line_num} {energy_sens} hyst show	shows hysteresis value for line meter	
linesensor {line_num} {energy_sens} publish mode set {NONE=0 INTERVAL=1 DELTA=2 INTERV_DELTA=3}	sets publish mode	
linesensor {line_num} {energy_sens} publish mode show	shows publish mode	
linesensor {line_num} {energy_sens} publish mqtt retain set {OFF=0 ON=1}	sets mqtt retain	
linesensor {line_num} {energy_sens} publish mqtt retain show	shows if mqtt retain set	
linesensor {line_num} {energy_sens} publish timer set {num_secs}	sets publish time interval	
linesensor {line_num} {energy_sens} publish timer show	shows publish time interval	
linesensor {line_num} {energy_sens} publish delta set {float}	sets publish delta value	
linesensor {line_num} {energy_sens} publish delta show	shows publish delta value	
linesensor {line_num} {energy_sens} {BELOWMIN=0 ABOVEMIN=1 ABOVEMAX=2 BELOWMAX=3} port list set "{port_list}"	set Ports for Port Switching actions	5
linesensor {line_num} {energy_sens} {BELOWMIN=0 ABOVEMIN=1 ABOVEMAX=2 BELOWMAX=3} port list show	show Port list for Port Switching actions	5
linesensor beeper set {OFF=0 ON=1}	enables beeper for line meter alarms	
linesensor beeper show	shows if beeper for line meter alarms is enabled	
modbus		
modbus enabled set <off=0/on=1>	enables Modbus TCP support	
modbus enabled show	shows if Modbus is enabled	
modbus port set <ip_port>	sets Modbus TCP port	
modbus port show	shows Modbus TCP port	
mqtt		
mqtt {broker_idx} enabled set {OFF=0 ON=1}	enable mqtt	
mqtt {broker_idx} enabled show	shows if mqtt enabled	
mqtt {broker_idx} server set "{dns_name}"	sets broker name	
mqtt {broker_idx} server show	shows broker name	
mqtt {broker_idx} tls enabled set {OFF=0 ON=1}	enable TLS	
mqtt {broker_idx} tls enabled show	shows if TLS enabled	
mqtt {broker_idx} port set {ip_port}	set broker TCP/IP port	
mqtt {broker_idx} port show	shows broker TCP/IP port	
mqtt {broker_idx} user set "{username}"	sets username	
mqtt {broker_idx} user show	shows username	
mqtt {broker_idx} passwd set "{passwd}"	sets password	
mqtt {broker_idx} passwd hash set "{passwd}"	sets hashed passwd	
mqtt {broker_idx} client set "{name}"	sets client name	
mqtt {broker_idx} client show	shows client name	
mqtt {broker_idx} qos set {QOS0=0 QOS1=1}	sets QoS level	
mqtt {broker_idx} qos show	shows QoS level	
mqtt {broker_idx} keepalive set {num_secs}	sets keep-alive time	
mqtt {broker_idx} keepalive show	shows keep-alive time	
mqtt {broker_idx} topic set "{name}"	sets topic prefix	

Specifications

mqtt {broker_idx} topic show	shws topic prefix	
mqtt {broker_idx} console enabled set {OFF=0 ON=1}	permit console cmds	
mqtt {broker_idx} console enabled show	shows if console cmds allowed	
mqtt {broker_idx} device data timer set {num_secs}	sets telemetry interval	
mqtt {broker_idx} device data timer show	shows telemetry interval	
port	enters cmd group "port"	
port {port_num} state set {OFF=0 ON=1}	sets port to new state	
port {port_num} state show	shows port state	
port all state set "{port_list}" {OFF=0 ON=1}	sets several ports in one cmd - e.g. port all state set "1,3,5" 1	
port all state {MODE0=0 MODE1=1 MODE2=2} show	shows all port states in 3 different view modes	4
port all set {OFF=0 ON=1 OFF_REV=2 ON_REV=3}	switch all ports on/off forward or reverse	
port all set {OFF=0 ON=1 OFF_REV=2 ON_REV=3} delay {num}	switch all ports on/off forward or reverse with delay in seconds	
port restart all set {REINIT=0 OFF_REV_REINIT=1,OFF_REINIT=2}	reinit coldstart sequence (optional first all off)	
port all off dir set {NORMAL=0 REVERSE=1}	sets the direction of the all port off sequence	
port all off dir show	shows the direction of the all port off sequence	
port {port_num} reset	start reset sequence for port	
port {port_num} toggle	toggles port	
port {port_num} batch set {OFF=0 ON=1} wait {num_secs} {OFF=0 ON=1}	starts batch mode for port	
port {port_num} batch cancel	cancel batch mode	
port {port_num} label set "{name}"	sets port label name	
port {port_num} label show	shows port label name	
port {port_num} initstate coldstart set {OFF=0 ON=1 REMEMBER=2}	sets port coldstart initialization	
port {port_num} initstate coldstart show	shows port coldstart initialization	
port {port_num} initstate delay set {num}	sets port init delay	
port {port_num} initstate delay show	shows port init delay	
port {port_num} repowerdelay set {num}	sets port repower delay	
port {port_num} repowerdelay show	shows port repower delay	
port {port_num} resettime set {num}	sets port reset duration	
port {port_num} resettime show	shows port reset duration	
port {port_num} watchdog enabled set {OFF=0 ON=1}	sets port watchdog to on/off	
port {port_num} watchdog enabled show	shows port watchdog state	
port {port_num} watchdog mode set {OFF=0 PORT_RESET=1 IP_MS=2 IP_MS_INV=3}	sets port watchdog mode	
port {port_num} watchdog mode show	shows port watchdog mode	
port {port_num} watchdog type set {WD_ICMP=0 WD_TCP=1}	sets port watchdog type	
port {port_num} watchdog type show	shows port watchdog type	
port {port_num} watchdog link down set {OFF=0 ON=1}	sets if watchdog active when eth link down	
port {port_num} watchdog link down show	shows if watchdog active when eth link down	
port {port_num} watchdog host set "{dns_name}"	sets port watchdog host target	
port {port_num} watchdog host show	shows port watchdog host target	
port {port_num} watchdog port set {ip_port}	sets port watchdog TCP port	
port {port_num} watchdog port show	shows port watchdog TCP port	
port {port_num} watchdog pinginterval set {num}	sets port watchdog ping interval	
port {port_num} watchdog pinginterval show	shows port watchdog ping interval	
port {port_num} watchdog pingretries set {num}	sets port watchdog ping retries	
port {port_num} watchdog pingretries show	shows port watchdog ping retries	
port {port_num} watchdog retrybooting set {OFF=0 ON=1}	sets port watchdog retry booting to on/off	
port {port_num} watchdog retrybooting show	shows port watchdog retry booting state	
port {port_num} watchdog bootretries set {num}	sets port watchdog retry boot timeout	
port {port_num} watchdog bootretries show	shows port watchdog retry boot timeout	
portsensor	enters cmd group "portsensor"	
portsensor all {field_list} show	shows energy sensors according field list of all port sensors	5
portsensor {port_num} {field_list} show	shows energy sensors according field list of one port sensor	5
portsensor {port_num} {energy_sensor} value show	shows energy sensor of given port	5
portsensor {port_num} counter reset	resets energy metering counter	
portsensor {port_num} {energy_sens} events set {OFF=0 ON=1}	enables sensor events on/off	
portsensor {port_num} {energy_sens} events show	shows if sensor events are enabled	
portsensor {port_num} {energy_sens} events type	enables different event types	

Specifications

set "{EVT_SYSLOG=0,EVT_SNMP=1,EVT_EMAIL=2 ,EVT_SMS=3,EVT_GSMEMAIL=4,EVT_BEEPER =5,EVT_DISPLAY=6,EVT_CONSOLE=7,EVT_M QTT=8}"		
portsensor {port_num} {energy_sens} events type show	shows what event types are enabled	
portsensor {port_num} {energy_sens} events beeper mode set {CONTINUOUS=0 INTERMITTENT=1}	sets beeper tone	
portsensor {port_num} {energy_sens} events beeper mode show	shows beeper tone	
portsensor {port_num} {energy_sens} maxval set {num}	sets maximum value for sensor	
portsensor {port_num} {energy_sens} maxval show	shows maximum value for sensor	
portsensor {port_num} {energy_sens} minval set {num}	sets minimum value for sensor	
portsensor {port_num} {energy_sens} minval show	shows minimum value for sensor	
portsensor {port_num} {energy_sens} hyst set {num}	sets hysteresis value for sensor	
portsensor {port_num} {energy_sens} hyst show	shows hysteresis value for sensor	
portsensor {port_num} {energy_sens} publish mode set {NONE=0 INTERVAL=1 DELTA=2 INTERV_DELTA=3}	sets publish mode	
portsensor {port_num} {energy_sens} publish mode show	shows publish mode	
portsensor {port_num} {energy_sens} publish mqtt retain set {OFF=0 ON=1}	sets mqtt retain	
portsensor {port_num} {energy_sens} publish mqtt retain show	shows if mqtt retain set	
portsensor {port_num} {energy_sens} publish timer set {num_secs}	sets publish time interval	
portsensor {port_num} {energy_sens} publish timer show	shows publish time interval	
portsensor {port_num} {energy_sens} publish delta set {float}	sets publish delta value	
portsensor {port_num} {energy_sens} publish delta show	shows publish delta value	
portsensor {port_num} {energy_sens} {BELOWMIN=0 ABOVEMIN=1 ABOVEMAX=2 BELOWMAX=3} port list set "{port_list}"	set Ports for Port Switching actions	5
portsensor {port_num} {energy_sens} {BELOWMIN=0 ABOVEMIN=1 ABOVEMAX=2 BELOWMAX=3} port list show	show Port list for Port Switching actions	5
portsensor {port_num} events set {OFF=0 ON=1}	LEGACY - enables sensor events on/off	L
portsensor {port_num} events show	LEGACY - shows if sensor events are enabled	L
portsensor {port_num} events type set "{EVT_SYSLOG=0,EVT_SNMP=1,EVT_EMAIL=2 ,EVT_SMS=3,EVT_GSMEMAIL=4,EVT_BEEPER =5,EVT_DISPLAY=6,EVT_CONSOLE=7,EVT_M QTT=8}"	LEGACY - enables different event types	1
portsensor {port_num} events type show	LEGACY - shows what event types are enabled	L
portsensor {port_num} maxval set {num}	LEGACY - sets maximum value for sensor	L
portsensor {port_num} maxval show	LEGACY - shows maximum value for sensor	L
portsensor {port_num} minval set {num}	LEGACY - sets minimum value for sensor	L
portsensor {port_num} minval show	LEGACY - shows minimum value for sensor	L
portsensor {port_num} hyst set {num}	LEGACY - sets hysteresis value for sensor	L
portsensor {port_num} hyst show	LEGACY - shows hysteresis value for sensor	L
radius	enters cmd group "radius"	
radius {PRIMARY=0 SECONDARY=1} enabled set <off=0/on=1>	enables radius client	
radius {PRIMARY=0 SECONDARY=1} enabled show	show if radius client enabled	
radius {PRIMARY=0 SECONDARY=1} server set "<dns_name>"	sets radius server address	
radius {PRIMARY=0 SECONDARY=1} server show	shows radius server address	
radius {PRIMARY=0 SECONDARY=1} password set "{passwd}"	sets radius server shared secret	
radius {PRIMARY=0 SECONDARY=1} password hash set "{passwd}"	sets radius server crypted shared secret	
radius {PRIMARY=0 SECONDARY=1} auth timeout set {num_secs}	sets server request timeout	
radius {PRIMARY=0 SECONDARY=1} auth timeout show	shows server request timeout	

Specifications

radius {PRIMARY=0 SECONDARY=1} retries set {0..99}	sets server number of retries
radius {PRIMARY=0 SECONDARY=1} retries show	shows server number of retries
radius chap enabled set <off=0/on=1>	enables CHAP
radius chap enabled show	shows if CHAP is enabled
radius message auth set <off=0/on=1>	enables request message authentication
radius message auth show	shows if request message authentication is enabled
radius default timeout set {num_secs}	sets default session timeout (when not returned as Session-Timeout Attribute)
radius default timeout show	shows default session timeout
snmp	enters cmd group "snmp"
snmp port set {ip_port}	sets SNMP UDP port
snmp port show	shows SNMP UDP port
snmp snmpget enabled set {OFF=0 ON=1}	enables SNMP GET cmds on/off
snmp snmpget enabled show	shows if SNMP GET cmds are enabled
snmp snmpset enabled set {OFF=0 ON=1}	enables SNMP SET cmds on/off
snmp snmpset enabled show	shows if SNMP SET cmds are enabled
snmp snmpv2 enabled set {OFF=0 ON=1}	sets SNMP v2 on/off
snmp snmpv2 enabled show	shows if SNMP v2 is enabled
snmp snmpv2 public set "{text}"	sets SNMP v2 public community
snmp snmpv2 public show	shows SNMP v2 public community
snmp snmpv2 private set "{text}"	sets SNMP v2 private community
snmp snmpv2 private show	shows SNMP v2 private community
snmp system {CONTACT=0 NAME=1 LOCATION=2} set "{text}"	sets sysLocation/sysName/sysContact
snmp system {CONTACT=0 NAME=1 LOCATION=2} show	gets sysLocation/sysName/sysContact
snmp snmpv3 enabled set {OFF=0 ON=1}	sets SNMP v3 on/off
snmp snmpv3 enabled show	shows if SNMP v3 is enabled
snmp snmpv3 username set "{text}"	sets SNMP v3 username
snmp snmpv3 username show	shows SNMP v3 username
snmp snmpv3 authalg set {NONE=0 MD5=1 SHA1=2 SHA256=3 SHA384=4 SHA512=5}	sets SNMP v3 authentication
snmp snmpv3 authalg show	show SNMP v3 authentication algorithm
snmp snmpv3 privalg set {NONE=0 DES=1 3DES=2 AES128=3 AES192=4 AES256=5 AES192*=6 AES256*=7}	sets SNMP v3 privacy algorithm
snmp snmpv3 privalg show	show SNMP v3 privacy algorithm
snmp snmpv3 authpasswd set "{passwd}"	sets SNMP v3 authentication password
snmp snmpv3 privpasswd set "{passwd}"	sets SNMP v3 privacy password
snmp snmpv3 authpasswd hash set "{passwd}"	sets SNMP v3 authentication hashed password
snmp snmpv3 privpasswd hash set "{passwd}"	sets SNMP v3 privacy hashed password
snmp trap type set {NONE=0 V1=1 V2=2 V3=3}	sets type of SNMP traps
snmp trap type show	show SNMP trap type
snmp trap receiver {trap_num} set "{dns_name}"	sets address and port of SNMP trap receiver {trap_num}
snmp trap receiver {trap_num} show	show address and port of SNMP trap receiver {trap_num}
syslog	enters cmd group "syslog"
syslog enabled set {OFF=0 ON=1}	enables syslog msgs on/off
syslog enabled show	show if syslog enabled
syslog server set "{dns_name}"	sets address of syslog server
syslog server show	shows address of syslog server
system	enters cmd group "system"
system beeper manual set {OFF=0 ON=1} {millisec}	manually sets beeper with optional duration
system beeper manual show	shows beeper state
system restart	restarts device
system fabsettings	restore fab settings and restart device
system bootloader	enters bootloader mode
system flushdns	flush DNS cache
system uptime	number of seconds the device is running
system name show	shows device name
system version show	shows actual firmware version
system display {disp_num} default bank {bank_num} set {energy_sens}	shows energy bank sensor
system display {disp_num} default extsensor {port_num} {sen_type} set {sen_field}	shows external sensor
system display {disp_num} default linesensor {line_num} set {sen_field}	shows energy line sensor
system display {disp_num} default portsensor {port_num} set {sen_field}	shows energy port sensor

Specifications

system display {disp_num} default set {BLANK=0,LOCAL_TIME=1,UTC_TIME=2}	shows other contents
system display {disp_num} default show	shows default setting for display
system display default hash set "{data}"	sets hashed display setting
system display default hash show	shows hashed display setting
system locale {TEMP=0 AIR_PRESS=1} set {num}	sets locale for external sensor
system locale {TEMP=0 AIR_PRESS=1} show	shows locale for external sensor
system sensor {VSYS=0 VAUX=1 VMAIN=2 TCPU=3} show	shows internal sensors if model supports it
system {SWITCH_PORT=0 EFUSE_FAIL=1} events set {OFF=0 ON=1}	enable global events
system {SWITCH_PORT=0 EFUSE_FAIL=1} events show	shows if global events enabled
system {SWITCH_PORT=0 EFUSE_FAIL=1} events type set "{EVT_SYSLOG=0,EVT_SNMP=1,EVT_EMAIL=2,EVT_SMS=3,EVT_GSMEMAIL=4,EVT_BEEPER=5,EVT_DISPLAY=6,EVT_CONSOLE=7,EVT_MQTT=8}"	enables different event types
system {SWITCH_PORT=0 EFUSE_FAIL=1} events type show	shows what event types are enabled
system {SWITCH_PORT=0 EFUSE_FAIL=1} events mqtt retain set {OFF=0 ON=1}	sets mqtt retain
system {SWITCH_PORT=0 EFUSE_FAIL=1} events mqtt retain show	shows if mqtt retain set
system fan mode set {AUTO=0 FULL=1}	sets fan mode
system fan mode show	shows fan mode
system fan level show	shows fan level
system panel enabled set {OFF=0 ON=1}	blocks panel buttons when not enabled
system panel enabled show	shows if panel buttons are enabled
system panel port all set {OFF=0 ON=1}	enable switch all relays from panel buttons
system panel port all show	shows if switch all relays from panel buttons enabled
timer	enters cmd group "timer"
timer enabled set {OFF=0 ON=1}	enables timer functions
timer enabled show	shows if timer a enabled
timer syslog facility set {0..23}	sets facility level for timer syslog
timer syslog facility show	shows facility level for timer syslog
timer syslog verbose set {0..7}	sets verbose level for timer syslog
timer syslog verbose show	shows verbose level for timer syslog
timer {rule_num} enabled set {OFF=0 ON=1}	enables rule
timer {rule_num} enabled show	shows if rule is enabled
timer {rule_num} name set "{name}"	sets name of rule
timer {rule_num} name show	shows name of rule
timer {rule_num} {FROM=0 UNTIL=1} set "{yyyy-mm-dd}"	sets date range of rule
timer {rule_num} {FROM=0 UNTIL=1} show	shows date range of rule
timer {rule_num} trigger jitter set {0..65535}	sets jitter for rule
timer {rule_num} trigger jitter show	show jitter of rule
timer {rule_num} trigger random set {0..100}	sets probability for rule
timer {rule_num} trigger random show	shows rule probability
timer {rule_num} trigger {HOUR=0 MIN=1 SEC=2 DAY=3 MON=4 DOW=5} set "{time_date_list}"	sets time date list
timer {rule_num} trigger {HOUR=0 MIN=1 SEC=2 DAY=3 MON=4 DOW=5} show	shows time date list
timer {rule_num} action mode set {SWITCH=1 CLI=2}	sets switch or cli cmd
timer {rule_num} action mode show	shows if switch or cli cmd
timer {rule_num} action {SWITCH1=0 SWITCH2=1} {OFF=0 ON=1} set "{port_list}"	sets port list for switch cmd
timer {rule_num} action {SWITCH1=0 SWITCH2=1} {OFF=0 ON=1} show	shows port list for switch cmd
timer {rule_num} action delay set {0..65535}	delay between cmds
timer {rule_num} action delay show	shows delay between cmds
timer {rule_num} action console set "{cmd}"	sets cmd string
timer {rule_num} action console show	shows cmd string
timer {rule_num} action hash set "{data}"	sets action binary form
timer {rule_num} action hash show	shows action binary form
timer {rule_num} delete	delete one timer
timer delete all	delete all timer
vt100	enters cmd group "vt100"
vt100 echo set {OFF=0 ON=1}	sets console echo state
vt100 echo show	shows console echo state
vt100 numeric set {OFF=0 ON=1}	sets numeric mode

vt100 numeric show	shows numeric mode state
vt100 reset	resets terminal

Notes

1. Legacy - The command has been replaced by a newer version
2. Command can be entered on any level
3. The output may show 2 lines - the 1st line shows the actual state, the 2nd line the status after reboot
4. The output may show several lines
5. Please see the **Energy Sensor Table** for the right energy index
6. Please see the **External Type and External Sensor Field Tables** for the correct sensor index

Energy Sensor Table "{energy_sensor}"

Index	Description	Unit
0	Forward Active Energy	kWh
1	Power Active	W
2	Voltage	V
3	Current	A
4	Frequency	0.01 hz
5	Power Factor	0.001
6	Power Angle	0.1 degree
7	Power Apparent	VA
8	Power Reactive	VAR
9	Forward Active Energy Resettable	kWh
10	Forward Reactive Energy	kVARh
11	Forward Reactive Energy Resettable	kVARh
12	Reset Time - sec. since last Energy Counter Reset	s
13	Reverse Active Energy	kWh
14	Reverse Reactive Energy	kVARh
15	Reverse Active Energy Resettable	kWh
16	Reverse Reactive Energy Resettable	kVARh
17	Absolute Active Energy	kWh
18	Absolute Reactive Energy	kVARh
19	Absolute Active Energy Resettable	kWh
20	Absolute Reactive Energy Resettable	kVARh
21	Residual Current	A

 Dependent on the device model Residual Current may not be supported

Bank DC Energy Sensor Table "{energy_sensor}"

Index	Description	Unit
0	Voltage	V
1	Current	A

External Sensor Type Table "{sen_type}"

Constants "{7x01=0|7x04=0|7x02=1|7x05=1|7x06=2}"

Index	Description	Products
0	Temperature	7001, 7101, 7201
0	Temperature	7004, 7104, 7204, 7208

Specifications

1	Temperature, Humidity	7002, 7102, 7202
1	Temperature, Humidity	7005, 7105, 7205, 7209
2	Temperature, Humidity, Air Pressure	7006, 7106, 7206, 7210

External Sensor Field Table "{sen_field}"

Index	Description	Unit
0	Temperature	°C / °F
1	Humidity	%
3	Air Pressure	hPa / inHg
4	Dew Point	°C / °F
5	Dew Point Temperature Difference	°C / °F

 The temperature or air pressure unit depends on the configuration.

4.3.3 Serial Console

If the device has a serial port, the entire console command set for Telnet is also available at the serial console. Connect your PC to the device via an RS232 serial cable. To use the editing functions, the serial terminal must support VT100 emulation, and "echo" must not be activated. In the device configuration on the other hand, "Activate echo" should be set to "yes" and "Raw mode" to "no". Start your terminal program and select the COM port to which the RS232 cable is connected. Use the following settings for the serial port:

Baudrate	115200
Databits	8
Parity	No
Stopbits	1
Flow Control	No

KVM Protocol

For compatibility reasons, the KVM protocol can also be activated on the serial port. These binary control sequences can be used for devices with power ports, to turn the relays on and off individually.

Syntax:

w x y z

- **w** prefix 0x80
- **x** command (0x31 to turn on, 0x32 for turning off)
- **y** port number (0x01 ...)
- **z** check byte, must be: `\x xor \y`

 Before the KVM protocol is recognized, the Enable binary KVM protocol entry must be activated in the "Console" configuration.

KVM Examples

Port	Power On	Power Off
1	0x80 0x31 0x01 0x30	0x80 0x32 0x01 0x33
2	0x80 0x31 0x02 0x33	0x80 0x32 0x02 0x30
12	0x80 0x31 0x0C 0x3D	0x80 0x32 0x0C 0x3E

4.4 HTTP Authentication

In the past, only *HTTP Basic Access Authentication* was supported as password authentication for Gude devices. Now cookie-based *Session Authentication* is used by default. This has the following advantages:

- Clicking on the "Logout" tab now mandatorily results in having to provide user name and password again to get into the device. This is often not the case with Basic Access Authentication because it is under the control of the web browser.
- Session Authentication is less susceptible to cross-site scripting. In addition, enhanced security can be configured by using a CSRF-Token.
- Combined with Session Authentication is a configurable logout time, where the login page is automatically referred to after inactivity.

Configuration of the Session Authentication

Session Timeout (admin): (seconds)
Session Timeout (user): (seconds)
Select Authentication Mode: ▾

You can select the automatic logout times in case of inactivity and the Session Authentication mode in the Ethernet configuration (sub-selection HTTP Server). If the logout time is zero, there is no automatic logout. The authentication modes are:

1. Basic Compatible: Basic Access and Session Authentication are accepted.
2. Session: Only Session Authentication is allowed.
3. Session Extended: A CSRF-Token token is required in addition to Session Authentication.

 Session and Session Extended modes behave slightly differently in the web interface: If you open a new browser tab for a running session in Session mode, no new login is required. In Session Extended mode, if a new tab is opened, the user name and password must be re-entered. This is because the CSRF-Token is stored locally to the tab in the web browser.

Compatibility with previous Basic Accesses

- In Basic Compatible mode, normal accesses with Basic Access Authentication are possible. Also everything may be accessed with a HTTP GET request. This leads to compatibility with controllers and drivers already on the market that communicate with Gude devices.
- If not accessed with Basic Access Authentication but with Session Authentication, CGI queries with passwords, configuring the device and switching relays are no longer allowed with HTTP GET requests. A POST request must be used.

 If you have logged in to the web interface once with Session Authentication, the system will automatically try to work with Session Authentication. If you want to use

Basic Access Authentication, you must first delete the session cookies and then access a page that is not the login page.

Authentication examples

To demonstrate how scripts can perform the different authentication modes, here are command line examples using curl:

Basic Access Authentication

```
curl -u "admin:test" "192.168.0.10/status.json?components=16"
```

Session Authentication with Cookies

```
curl --cookie-jar sess_cook_curl.txt -d "username=admin&password=test" \
  192.168.0.10/login.json
curl --cookie sess_cook_curl.txt 192.168.0.10/status.json?components=16
```

Session authentication with cookies and CSRF-Token

```
curl --cookie-jar sess_cook_curl.txt -d "username=admin&password=test" \
  192.168.0.10/login.json
brings a JSON output like: {"login":1,"sessionidX":"a4b9cfc54b273b2af3ba84b8f413b6e9","user_id":1,"href":"dashboard.html"}
curl --cookie sess_cook_curl.txt -d "components=16&cmd=1&p=1&s=0" -H \
  "sessionidX: a4b9cfc54b273b2af3ba84b8f413b6e9" 192.168.0.10/status.json
```

 In this example, the CSRF-Token sessionidX from the output of the first curl call was added as an additional header in the second curl call.

4.5 IP ACL

IP Access Control List

The IP Access Control List (ACL IP) is a filter for incoming IP packets. If the filter is active, only the hosts and subnets whose IP addresses are registered in the list, can contact via HTTP or SNMP, and make changes. For incoming connections from unauthorized PCs, the device is not completely transparent. Due to technical restraints, a TCP/IP connection will be accepted at first, but then rejected directly.

Examples:

Entry in the IP ACL	Meaning
192.168.0.123	the PC with IP Address "192.168.0.123" can access the device
192.168.0.1/24	all devices of subnet "192.168.0.1/24" can access the device
1234:4ef0:eec1:0::/64	all devices of subnet "1234:4ef0:eec1:0::/64" can access the device

 If you choose a wrong IP ACL setting and locked yourself out, please activate the Bootloader Mode and use GBL_Conf.exe to deactivate the IP ACL. Alternatively, you can reset the device to factory default.

4.6 IPv6

IPv6 Addresses

IPv6 addresses are 128 bit long and thus four times as long as IPv4 addresses. The first 64 bit form a so-called prefix, the last 64 bit designate a unique interface identifier. The prefix is composed of a routing prefix and a subnet ID. An IPv6 network interface can be reached under several IP addresses. Usually this is the case under a global address and the link local address.

Address Notation

IPv6 addresses are noted in 8 hexadecimal blocks at 16 bit, while IPv4 normally is noted in decimal. The separator is a colon, not a period.

E.g.: 1234:4ef0:0:0:0019:32ff:fe00:0124

Leading zeros may be omitted within a block. The previous example can be rewritten as:

1234:4ef0:0:0:19:32ff:fe00:124

One may omit one or more successive blocks, if they consist of zeros. This may be done only once within an IPv6 address!

1234:4ef0::19:32ff:fe00:124

One may use the usual decimal notation of IPv4 for the last 4 bytes:

1234:4ef0::19:32ff:254.0.1.36

4.7 Messages

Depending on adjustable events, various messages can be sent from the device. The following message types are supported:

- Sending of e-mails
- SNMP Traps
- Syslog messages

E-Mail messages

Email messages are triggered by the following events:

- Switching of the Ports
- Exceeding of the max / min values of attached sensors
- State change of digital sensor input ports

SNMP Traps

Specifications

SNMP Traps are system messages that are sent via the SNMP protocol to different recipients. SNMP traps are triggered by the following events:

- Switching of the Ports
- Exceeding of the max / min values of attached sensors
- State change of digital sensor input ports

Syslog messages

Syslog messages are simple text messages that are sent via UDP to a syslog server. Under Linux, normally a syslog daemon is already running (e.g. syslog-ng), for Microsoft Windows systems some freeware programs are available on the market. The syslog messages are sent for the following events:

- Turning on the device
- Enable/disable of syslog in the configuration
- Switching of the Ports
- Exceeding of the max / min values of attached sensors
- State change of digital sensor input ports

	SNMP Trap	Console	MQTT	Syslog	Email
Global					
Device started	x	x	x	x	x
Switch port	x	x	x	x	x
Port watchdog status	x	x	x	x	x
eFuse shutdown	x	x	x	x	x
Syslog switched on/off				x	
MQTT connection established			x	x	
MQTT connection lost				x	
Over-Voltage-Protection Status	x	x	x	x	x
Value-Threshold					
external sensors Current, Voltage, Power differential current Type A	x	x	x	x	x
Time-Interval					
external sensors Current, Voltage, Power differential current type A		x	x		
Value-Delta					
external sensors Current, Voltage, Power differential current type A		x	x		

SNMP traps

There are common traps for state changes of the same device resource. For example, a SwitchEvtPort trap is sent when a port is turned on or off. The state change itself is conveyed by the supplied data within the trap.

MQTT published data

Messages on the MQTT channel are sent in JSON format.

Example switch a port: `"{"type": "portswitch", "idx": 2, "port": "2", "state": 1, "cause": {"id": 2, "txt": "http"}, "ts": 1632}"`

Console Push Messages

Push messages can be activated on the console channels (Telnet, SSH or serial console), which output sensor values at timed intervals (every n seconds) or as of a configurable change in the magnitude of the sensor value on that channel. The generated message always starts with a "#" and ends with a CR/LF.

Example: Switch a port: "#port 2 ON"

If you open a telnet or SSH connection, the push messages are either preconfigured, or you switch on the push messages temporarily with "console telnet pushmsgs set 1" (or "console ssh pushmsgs set 1"). From now on, push messages will be sent asynchronously on this channel. The asynchronous nature of the messages can cause problems on a connection if you send commands yourself at the same time. There are then the possibilities:

- Filter all incoming characters between "#" and CR/LF
- or open a second channel (Telnet, SSH, serial) and switch on the push messages there.

4.8 Modbus TCP

 **Important:** All calculations in this chapter are based on addresses starting at "0". For some Modbus TCP Utilities, however, the addresses start at 1, in which case a 1 must be added to the addresses in this chapter. Please try both possibilities for tests!

 **Important:** If an attempt is made to access registers that do not exist for the respective device, then an access error will occur. If a device has e.g. 8 relays, then only the first eight coils can be accessed without error!

If Modbus TCP is activated in the configuration, the ports (relays, outputs, eFuses) can be switched and the following data is callable:

Address range overview:

Device Resource	Start	End	Modbus Data Type
Power/Output/eFuse Ports	0x000	0x3ff	Coils
DC Inputs	0x400	0x7ff	Discrete Inputs
Stop Condition active	0x800	0x800	Discrete Inputs
POE active	0x801	0x801	Discrete Inputs
Status Power Sources	0x1000	0x100f	Discrete Inputs
OVP active (Line-Ins)	0x1010	0x101f	Discrete Inputs
Fuse ok	0x1020	0x102f	Discrete Inputs
ETS Input Power nominal	0x1030	0x1031	Discrete Inputs
eFuse Errors	0x1100	0x11ff	Discrete Inputs
Info Area	0x000	0x005	Input Registers
CPU Sensor values	0x080	0x083	Input Registers
External Sensors	0x100	0x1ff	Input Registers
Fan Level	0x200	0x20f	Input Registers
Line Energy Sensors	0x400	0x39ff	Input Registers
Port Energy Sensors	0x3a00	0x81ff	Input Registers
Bank Energy Sensors	0x8200	0x823f	Input Registers

Specifications

Power Source Sensors	0x8240	0x827f	Input Registers
Residual Current Monitor	0x8280	0x82cf	Input Registers
DC Input toggle counter	0x8300	0x8aff	Input Registers
Total Energy Sensors	0x8b00	0x8cff	Input Registers
Bank Power Source Select	0x000	0x00f	Holding Registers
Fan Mode	0x010	0x01f	Holding Registers

 This chapter is general for all Gude devices. Depending on the device type, some ports or certain sensors are not available.

The Unit-ID is ignored because the device is uniquely identified by its IP address.

Supported Modbus TCP Functions

Function	Request Code
Read Coils	0x01
Read Discrete Inputs	0x02
Write Single Coil	0x05
Write Multiple Coils	0x0f
Read Input Registers	0x04
Read Holding Registers	0x03
Write Holding Register	0x06
Write Multiple Holding Registers	0x10
Read Device Identification	0x2B / 0x0E

Coils

Device Resource	Start	End	Device Function
Power/Output/eFuse	0x000	0x3ff	Coil represents Port State

Switching ports

The power ports or output ports of a device are switched via coils, and the current port status can also be queried from the corresponding coil. The number of the port to be switched is transferred one-to-one to the addressing of the coils. For Gude devices with several banks, the ports are numbered consecutively according to ascending banks.

Discrete Inputs

Device Resource	Start	End	Function when set
DC Inputs	0x400	0x7ff	Input logically 1
Stop Condition active	0x800	0x800	Stop Input active
POE active	0x801	0x801	POE active
Status Power Sources	0x1000	0x100f	Power Source active
OVP active (Line-Ins)	0x1010	0x101f	OVP active
Fuse ok	0x1020	0x1020	Fuse functional (ETS 8801)
ETS Input Power normal	0x1030	0x1031	Voltage nominal (ETS 8801)
eFuse Error	0x1100	0x11ff	eFuse Error (EPC 8291)

Specifications

DC Inputs:

The DC inputs can be found in the *Discrete Inputs*. The inputs are arranged as follows:

Input: $0x0400 + \text{Port} * 0x40 + \text{Input-number}$ (starts with zero).

Port is the number of the external sensor port. For inputs permanently installed in the device, Port = 0.

Example for the first input at external input sensor in port 2: $0x400 + 2 * 0x40 + 0 = 0x480$

Status Power Sources:

Power Sources	Offset
EPC 8221 / 8226	0 = Bank A, 1 = Bank B
ENC 2111 / 2191	0 = Pwr1, 1 = Pwr2
ESB 7213 / 7214	0 = Pwr1, 1 = Pwr2 (only 7214)

Input Registers

Device Resource	Start	End	Function
Info Bereich	0x000	0x005	see table
CPU Sensor values	0x080	0x083	see table
Externe Sensoren	0x100	0x1ff	see table
Fan Level	0x200	0x20f	0 (off) to 3 (maximum)
Line Energy Sensors	0x400	0x39ff	see table
Port Energy Sensors	0x3a00	0x81ff	see table
Bank Energy Sensors	0x8200	0x823f	see table
Power Source Sensors	0x8240	0x827f	see table
Residual Current Monitor	0x8280	0x82cf	see table
DC Input toggle counter	0x8300	0x8aff	Counter
Total Energy Sensors	0x8b00	0x8cff	see table

Info Area

Address	Width	Information
0	16-bit	Number of Ports (Relay)
1	16-bit	Number of Ports (Outlets) with Energy Measurement
2	16-bit	Number of Banks
3	16-bit	Number of Line-In
4	16-bit	Phases per line
5	16-bit	Number of Inputs

Sensor Type Description

Address	Width	Information
0x080 to 0x083	16-bit (signed)	CPU Sensor values
0x100 to 0x1ff	16-bit (signed)	external Sensors
0x400 to 0x39ff	32-bit (signed)	Line Energy Sensors
0x3a00 to 0x81ff	32-bit (signed)	Port Energy Sensors

Specifications

0x8200 to 0x823f	16-bit (signed)	Bank Energy Sensors
0x8240 to 0x827f	16-bit (signed)	Power Source Energy Sensors
0x8280 to 0x82cf	16-bit (signed)	Residual Current Monitor
0x8300 to 0x8aff	32-bit (unsigned)	DC Input toggle counter
0x8b00 to 0x8cff	32-bit (signed)	Total Energy Sensors

CPU Sensor Values

Offset	Sensor Field	Unit
0	Vsystem	0.01 V
1	Vaux	0.01 V
2	Vmain	0.01 V
3	CPU Temperature	0.1 °C

External Sensors:

The measured value of the external sensors are coded as fixed point arithmetic. For a factor of e.g. 0.1 in the unit the value must be divided by 10 in order to reach the real measured value. A value of 0x8000 means that no sensor is plugged into the corresponding port, or the corresponding field in the sensor is not available. The formula for the address is (the port numbers start at zero):

$$0x100 + \text{Port} * 8 + \text{Offset}$$

 In the Expert Sensor Box 7213 / 7214 the internal sensor corresponds to the value Port = 0, and is coded Port = 1 for Sensor 2 and Port = 2 for Sensor 3. The temperature or air pressure unit depends on the configuration.

Offset	Sensor Field	Unit
0	Temperature	0.1 °C / °F
1	Humidity	0.1 %
2	Digital Input	bool
3	Air Pressure	1 hPa (mbar) / inHg
4	Dew Point	0.1 °C / °F
5	Dew Point Difference	0.1 °C / °F

For example, the humidity of the second port has the address: $0x100 + 1 * 8 + 1 = 0x109$

Energy Sensors:

 This applies to devices that support 230V input measurement (Line) and/or devices that support 230V output measurement (Port).

We distinguish the line sensors (which correspond to the input circuits) and the port sensors, which measure the energy that is passed over the switched port. The measured values of the energy sensors are returned as signed 32-bit integers. The high-order 16-bits are starting on the even address, followed by the low-order 16-bits on the odd address. To calculate the address, there are the following formulas (the values for line and port start at zero):

$$\text{Line: } 0x0400 + \text{Line} * 0x120 + \text{Offset} * 2$$

$$\text{Port: } 0x3a00 + \text{Port} * 0x120 + \text{Offset} * 2$$

Examples:

Specifications

"Power Active" for 1st line sensor: $0x400 + 0 * 0x120 + 1 * 2 = 0x402$

"Voltage" for 2nd line sensor: $0x400 + 1 * 0x120 + 2 * 2 = 0x524$

"Power Angle" for 4th port sensor and: $0x3a00 + 3 * 0x120 + 6 * 2 = 0x3d6c$

Offset	Sensor Field	Unit
0	Absolute Active Energy	Wh
1	Power Active	W
2	Voltage	V
3	Current	mA
4	Frequency	0.01 hz
5	Power Factor	0.001
6	Power Angle	0.1 degree
7	Power Apparent	VA
8	Power Reactive	VAR
9	Absolute Active Energy Resettable	Wh
10	Absolute Reactive Energy	VARh
11	Absolute Reactive Energy Resettable	VARh
12	Reset Time - sec. since last Energy Counter Reset	s
13	Forward Active Energy	Wh
14	Forward Reactive Energy	VARh
15	Forward Active Energy Resettable	Wh
16	Forward Reactive Energy Resettable	VARh
17	Reverse Active Energy	Wh
18	Reverse Reactive Energy	VARh
19	Reverse Active Energy Resettable	Wh
20	Reverse Reactive Energy Resettable	VARh
21	Residual Current Type A (only line sensors)	0.1 mA

 Whether the measured values "Neutral Current" are supported depends on the respective device model.

Total Energy Sensor:

The "Total" energy sensor is currently only used in 3-phase devices and contains measured values that only occur once and are not measured individually for each phase. The measured values of the energy sensors are returned as signed 32-bit integers. On the even address, the high-order 16 bits are returned first, followed by the low-order 16 bits on the odd address. The following formula is used for the address:

Total: $0x8b00 + \text{Offset} * 2$

Offset	Sensor Field	Unit
0	Neutral Current	mA

 It is planned to extend this table with later firmware updates.

DC Energy Sensors:

With the EPC 8291 / 8290 devices, the voltage and current of the individual banks and voltage sources can be read out. The measured values of the energy sensors are returned as signed 16-bit integers. The following formulas are available for the address (the values for Bank and PowerSrc start at zero):

Specifications

Bank: $0x8200 + \text{Bank} * 2 + \text{Offset}$

Power Source: $0x8240 + \text{PowerSrc} * 2 + \text{Offset}$

Examples:

"Voltage" at third bank: $0x8200 + 2 * 2 + 0 = 0x8204$

"Current" at first PowerSrc: $0x8240 + 0 * 2 + 1 = 0x8241$

Offset	Sensor Field	Unit
0	Voltage	0.01 V
1	Current	mA

Residual Current Monitor Type B (RCMB):

Devices with a Residual Current Monitor Type B (RCMB) module separately measure the RMS and DC fault current components of the input supply. The values are returned as signed 16-bit integers. The following formulas are used for the address (the module number starts at zero):

Bank: $0x8280 + \text{ModuleNo} * 8 + \text{Offset}$.

Examples:

"Residual Current DC" at first module: $0x8280 + 0 * 8 + 1 = 0x8281$.

"Output DC" for second module: $0x8280 + 1 * 8 + 3 = 0x828b$

Offset	Addr. Module 0	Sensor Field	Unit
0	0x8280	Residual Current RMS Type B	0.1 mA
1	0x8281	Residual Current DC Type B	0.1 mA
2	0x8282	Output RMS	bool
3	0x8283	Output DC	bool
4	0x8284	Module State	

 Whether a Residual Current Monitor Type B (RCMB) module is present depends on the particular device model.

DC input toggle counter

In these 32-bit counters, the value is incremented by one with each change at the DC input. The counters are returned as 32-bit unsigned integers. On the even address, the high-order 16 bits are first, followed by the low-order 16 bits on the odd address. The following formula applies to the address: (Port = 0 refers to internal inputs on the device, port numbers > 0 refer to inputs of the external sensors on the respective port):

$0x8300 + \text{port} * 0x80 + \text{input number} * 2$

 Only devices of the Expert Net Control type usually have internal inputs.

Holding Registers

Specifications

Device Resource	Start	End	Function
Bank Power Source	0x000	0x00f	Sets Power Source for Bank
Fan Mode	0x010	0x01f	0 = Automatic / 1 = Maximum

 Bank Power Source applies to EPC 8291 and ETS 8801 models. Only the EPC 8291 model has a fan.

Device Identification

Returns manufacturer name and device identification:

Request Code	1 Byte	0x2b
MEI Type	1 Byte	0x0e
Read Dev ID code	1 Byte	0x01
Object Id	1 Byte	0x00

Response Code	1 Byte	0x2b
MEI Type	1 Byte	0x0e
Read Dev ID code	1 Byte	0x01
Conformity Level	1 Byte	0x01
More Follows	1 Byte	0x00
NextObjectID	1 Byte	0x00
Number of Objects	1 Byte	0x03
Object ID	1 Byte	0x00
Object Length	1 Byte	n1
Object Value	n1 Bytes	"Company Id"
Object ID	1 Byte	0x00
Object Length	1 Byte	n2
Object Value	n2 Bytes	"Product Id"
Object ID	1 Byte	0x00
Object Length	1 Byte	n3
Object Value	n3 Bytes	"Product Version"

4.8.1 Sensor Tables

 **Important:** All calculations in this chapter are based on addresses starting at "0". With some Modbus TCP utilities the addresses start at 1. In this case a 1 must be added to the addresses in this chapter. Please try both possibilities for tests!

External sensors addresses (Input Register)

Sensor field	Port 1	Port 2
Temperature	0x100	0x108
Humidity	0x101	0x109
Digital input	0x102	0x10a
Air Pressure	0x103	0x10b
Dew Point	0x104	0x10c
Dew Point Difference	0x105	0x10d

A value of 0x8000 means that no sensor is plugged into the corresponding port or the corresponding field in the sensor is not available.

Line-In Energy Addresses (Input Register)

Offset	Sensor Field	Line 1
0	Absolute Active Energy	0x400
1	Power Active	0x402
2	Voltage	0x404
3	Current	0x406
4	Frequency	0x408
5	Power Factor	0x40a
6	Power Angle	0x40c
7	Power Apparent	0x40e
8	Power Reactive	0x410
9	Absolute Active Energy Resettable	0x412
10	Absolute Reactive Energy	0x414
11	Absolute Reactive Energy Resettable	0x416
12	Reset Time - sec. since Reset	0x418
13	Forward Active Energy	0x41a
14	Forward Reactive Energy	0x41c
15	Forward Active Energy Resettable	0x41e
16	Forward Reactive Energy Resettable	0x420
17	Reverse Active Energy	0x422
18	Reverse Reactive Energy	0x424
19	Reverse Active Energy Resettable	0x426
20	Reverse Reactive Energy Resettable	0x428
21	Residual Current Type A	0x42a

The measured values of the energy sensors are returned as signed 32-bit integers. On the even address, the high-order 16 bits are returned first, followed by the low-order 16 bits on the odd address.

Port Energy Addresses (eFuses - Input Register)

Offset	Sensor Field	Port A1	Port A2	Port A3	Port A4	Port A5
0	Voltage	0x3a00	0x3b20	0x3c40	0x3d60	0x3e80
1	Current	0x3a02	0x3b22	0x3c42	0x3d62	0x3e82
2	Power	0x3a04	0x3b24	0x3c44	0x3d64	0x3e84

Offset	Sensor Field	Port B1	Port B2	Port B3	Port B4
0	Voltage	0x40c0	0x41e0	0x4300	0x4420
1	Current	0x40c2	0x41e2	0x4302	0x4422
2	Power	0x40c4	0x41e4	0x4304	0x4424

Offset	Sensor Field	Port C1	Port C2	Port C3	Port C4
0	Voltage	0x4540	0x4660	0x4780	0x48a0
1	Current	0x4542	0x4662	0x4782	0x48a2
2	Power	0x4544	0x4664	0x4784	0x48a4

Offset	Sensor Field	Port D1	Port D2	Port D3	Port D4
0	Voltage	0x49c0	0x4ae0	0x4c00	0x4d20
1	Current	0x49c2	0x4ae2	0x4c02	0x4d22
2	Power	0x49c4	0x4ae4	0x4c04	0x4d24

The measured values of the energy sensors are returned as signed 32-bit integers. On the even address, the high-order 16 bits are returned first, followed by the low-order 16 bits on the odd address.

Bank Energy and Voltage Sources (Input Register)

Sensor Field	Bank 1	Bank 2	Bank 3	Bank 4	Bank 5
Voltage	0x8200	0x8202	0x8204	0x8206	0x8208
Current	0x8201	0x8203	0x8205	0x8207	0x8209

Sensor Field	Source 1	Source 2	Source 3	Source 4	Source 5
Voltage	0x8240	0x8242	0x8244	0x8246	0x8248
Current	0x8241	0x8243	0x8245	0x8247	0x8249

4.9 MQTT

This device supports MQTT 3.1.1 to send configured messages and also to receive commands. This chapter is general for all Gude devices, some Gude models do not have switchable ports.

- Default port for an unencrypted connection is port 1883.
- Default port for a TLS secured connection is port 8883.
- If the broker allows anonymous login, username and password are arbitrary, but a username must be specified.
- If multiple MQTT clients are connected to a broker, the names of the clients must be different. For this reason, "client_xxxx" is generated as the default name. Here "xxxx" are the last 4 digits of the MAC address.

Message format

The MQTT messages of the device are always sent in JSON format. E.G..

```
{"type": "portswitch", "idx": 2, "port": "2", "state": 1, "cause": {"id": 2, "txt": "http"}, "ts": 1632}
```

This is a switching of the second port to the state on. The source of the switching command is CGI ("http"). The index is always numeric, "port" can also be alphanumeric for devices with multiple banks, e.g. "A2". At the end follows a timestamp ("ts"), which shows the number of seconds the device has been switched on, or in Unix format in the local time zone if the device has synchronized with an NTP server.

MQTT Topic Prefix

The topic prefix for the messages can be set in the MQTT configuration. A default would be e.g. "de/gudesystems/epc/[mac]". Here "[mac]" is a placeholder for the MAC address of the device, another possible placeholder is "[host]", which contains the host name. An example topic for a switching message of the second port would then be:

```
"de/gudesystems/epc/00:19:32:01:16:41/switch/2".
```

Executing console commands

The device can be controlled remotely via MQTT using console commands. A list of all commands can be found in the [Console](#) chapter. Depending on the topic, the commands are accepted in different formats.

 As default the execution of commands is not allowed, but must be enabled in the MQTT configuration! ("Permit CLI commands")

Format 1: Command in JSON Syntax

Publish Topic: "de/gudesystems/epc/00:19:32:01:16:41/cmd"
Publish Message: "{\"type\": \"cli\", \"cmd\": \"port 2 state set 1\", \"id\": 10}"

Response from device to "de/gudesystems/epc/00:19:32:01:16:41/cmdres"
"{\"type\": \"cli\", \"cmdres\": [\"OK.\"], \"result\": {\"num\": 0, \"hint\": \"ok\"}, \"id\": 10}"

 The JSON object "result" returns whether the command was valid. The object "id" in the command is optional and is passed through in the response from the device. The passed number can help to establish a synchronicity between command and response via the broker.

Format 2: Raw Text

Publish Topic: "de/gudesystems/epc/00:19:32:01:16:41/cmd/cli"
Publish Message: "port 2 state set 1".

Response from device to "de/gudesystems/epc/00:19:32:01:16:41/cmdres/cli"
"OK."

Format 3: Simplified port switching

Publish Topic: "de/gudesystems/epc/00:19:32:01:16:41/cmd/port/2"
Publish Message: "0" or "1".

Response from device to "de/gudesystems/epc/00:19:32:01:16:41/cmdres/port/2"
"0" or "1"

 This special form exists only for the port switching commands.

Device Data Summary

In the **Device Data Summary** the most important data of the device are summarized in a JSON object and sent periodically in a configurable time interval. This summary depends on the properties of the device and the connected sensors, and could look like this:

Topic: en/gudesystems/epc/00:19:32:01:16:41/device/telemetry

Message:

```
{
  "type": "telemetry",
  "portstates": [{
    "port": "1",
    "name": "Power Port",
    "state": 1
  }, {
    "port": "2",
    "name": "Power Port",
    "state": 0
  }, {
    "port": "3",
    "name": "Power Port",
    "state": 0
  }, {
```

Specifications

```
        "port": "4",
        "name": "Power Port",
        "state": 0
    }},
    "line_in": [{
        "voltage": 242.48,
        "current": 0.000
    }],
    "sensors": [{
        "idx": 1,
        "name": "7105",
        "data": [{
            "field": "temperature",
            "v": 21.1,
            "unit": "deg C"
        }, {
            "field": "humidity",
            "v": 71.9,
            "unit": "%"
        }, {
            "field": "dew_point",
            "v": 15.8,
            "unit": "deg C"
        }, {
            "field": "dew_diff",
            "v": 5.3,
            "unit": "deg C"
        }
    ]
    }],
    "ts": 210520
}
```

4.9.1 Example HiveMQ

What does an MQTT configuration look like using HiveMQ as an example?

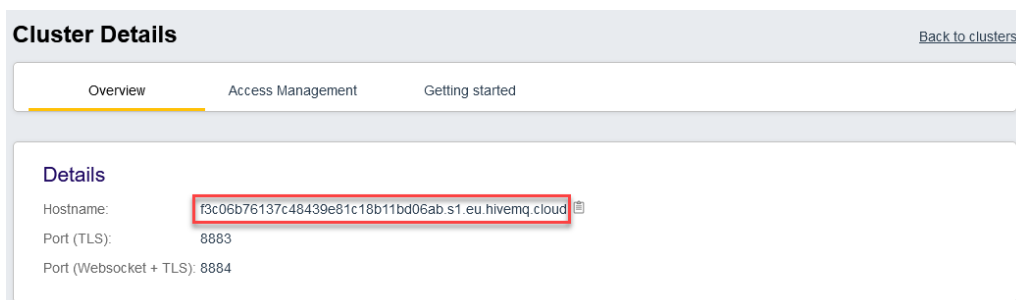

Cluster Details [Back to clusters](#)

Overview Access Management Getting started

Details

Hostname: f3c06b76137c48439e81c18b11bd06ab.s1.eu.hivemq.cloud

Port (TLS): 8883

Port (Websocket + TLS): 8884

Create a free or commercial account at www.hivemq.com and create a new cluster.

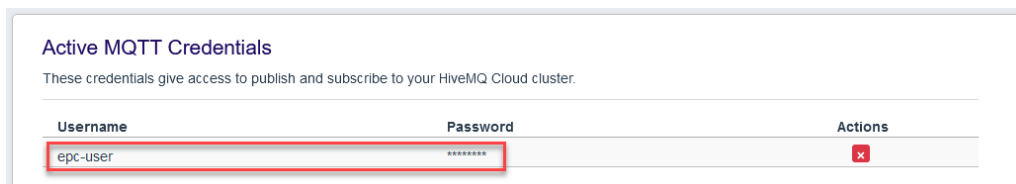

Active MQTT Credentials

These credentials give access to publish and subscribe to your HiveMQ Cloud cluster.

Username	Password	Actions
epc-user	*****	x

In the "Manage Clusters" section, go to "Access Management" and add an MQTT user with name and password.

MQTT

Enable MQTT: yes no

Broker:

TLS: yes no

TCP Port: (Default: 8883)

Username:

Set new password:

Repeat password:

Client ID:

Quality of Service (QoS): ▼

Keep-alive ping interval: s (minimum 10s)

Topic Prefix:
de/gudesystems/epc/00:19:32:01:16:41

Permit CLI commands: yes no

Publish device data summary interval: s (0=disabled)

In the MQTT configuration of the Gude device, transfer the hostname of the HiveMQ broker, as well as username and password. Additionally activate TLS and set the correct port.

4.10 Radius

The passwords for HTTP, telnet, and serial console (depending on the model) can be stored locally and / or authenticated via RADIUS. The RADIUS configuration supports a primary server and a backup server. If the primary server does respond, the RADIUS request is sent to the backup server. If the local password and RADIUS are enabled at the same time, the system is first checking locally, and then in the event of a failure the RADIUS servers are contacted.

RADIUS attributes

The following RADIUS attributes are evaluated by the client:

Session-Timeout: This attribute specifies (in seconds) how long an accepted RADIUS request is valid. After this time has elapsed, the RADIUS server must be prompted again. If this attribute is not returned, the default timeout entry from the configuration is used instead. Please set this value to 300 seconds or greater to prevent the radius requests from becoming too large.

Filter-Id: If the value "admin" is set for this attribute, then an admin rights are assigned for the login, otherwise only user access.

Service-Type: This is an alternative to Filter-Id. A service type of "6" or "7" means admin rights for the HTTP login, otherwise only limited user access.

HTTP Login

The HTTP login takes place via Basic Authentication. This means that it is the responsibility of the web server, how long the login credentials are temporarily stored there. The RADIUS parameter "Session-Timeout" therefore does not determine when the user has to login again, but at what intervals the RADIUS servers are asked again.

4.11 SNMP

SNMP can be used for status information via UDP (port 161). Supported SNMP commands are:

- GET
- GETNEXT
- GETBULK
- SET

To query via SNMP you need a Network Management System, such as HP OpenView, OpenNMS, Nagios etc., or the simple command line tools of NET-SNMP software. The device supports SNMP protocols v1, v2c and v3. If traps are enabled in the configuration, the device messages are sent as notifications (traps). SNMP Informs are not supported. SNMP Requests are answered with the same version with which they were sent. The version of the sent traps can be set in the configuration.

MIB Tables

The values that can be requested or changed by the device, the so-called "Managed Objects", are described in Management Information Bases (MIBs). These substructures are subordinate to so-called "OID" (Object Identifiers). An OID digit signifies the location of a value inside a MIB structure. Alternatively, each OID can be referred to with its symbol name (subtree name). The device's MIB table can be displayed as a text file by clicking on the link "MIB table" on the SNMP configuration page in the browser.

SNMP v1 and v2c

SNMP v1 and v2c authenticates the network requests by so-called communities. The SNMP request has to send along the so-called community public for queries (read access) and the community private for status changes (write access). The SNMP communities are read and write passwords. In SNMP v1 and v2 the communities are transmitted unencrypted on the network and can be easily intercepted with IP sniffers within this collision domain. To enforce limited access we recommend the use of DMZ or IP-ACL.

SNMP v3

Because the device has no multiuser management, only one user (default name "standard") is detected in SNMP v3. From the User-based Security Model (USM) MIB variables, there is a support of "usmStats ..." counter. The "usmUser ..." variables will be added with the enhancement of additional users in later firmware versions. The system has only one context. The system accepts the context "normal" or an empty context.

Authentication

The algorithms "HMAC-MD5-96" and "HMAC-SHA-96" are available for authentication. In addition, the "HMAC-SHA-2" variants (RFC7630) "SHA-256", "SHA-384" and "SHA-512" are implemented.

 "SHA-384" and "SHA512" are calculated purely in software. If "SHA-384" or "SHA-512" is set on the configuration page, the time for the key generation may take once up to approx. 45 seconds.

Encryption

The methods "DES", "3DES", "AES-128", "AES-192" and "AES-256" are supported in combination with "HMAC-MD5-96" and "HMAC-SHA-96." For the "HMAC-SHA-2" protocols, there is currently neither RFC nor draft that will allow for cooperation with an encryption.

 While in the settings "AES-192" and "AES256" the key calculation is based on "draft-blumenthalphoto-aes-usm-04", the methods "AES 192-3DESKey" and "AES 256-3DESKey" utilize a key generation, which is also used in the "3DES" configuration ("draft-reeder-snmpv3-usm-3desede-00"). If one is not an SNMP expert, it is recommended to try in each case the settings with and without "...- 3DESKey".

Passwords

The passwords for authentication and encryption are stored only as computed hashes for security reasons. Thus it is, if at all, very difficult to infer the initial password. However, the hash calculation changes with the set algorithms. If the authentication or privacy algorithms are changed, the passwords must be re-entered in the configuration dialog.

Security

The following aspects should be considered:

- If encryption or authentication is used, then SNMP v1 and v2c should be turned off. Otherwise the device could be accessed with it.
- If only authentication is used, then the new "HMAC-SHA-2" methods are superior to the MD5 or SHA-1 hashing algorithms. Since only SHA-256 is accelerated in hardware, and SHA-384 and SHA-512 are calculated purely in software, one should normally select SHA-256. From a cryptographic point of view, the security of SHA-256 is sufficient for today's usage.
- For SHA-1, there are a little less attack scenarios than MD5. If in doubt, SHA-1 is preferable.
- Encryption "DES" is considered very unsafe, use only in an emergency for reasons of compatibility!
- For cryptologists it's a debatable point whether "HMAC-MD5-96" and "HMAC-SHA-96" can muster enough entropy for key lengths of "AES-192" or "AES-256".
- From the foregoing considerations, we would recommend at present "HMAC-SHA-96" with "AES-128" as authentication and encryption method.

Change in Trap Design

 In older MIB tables, a separate trap was defined for each combination of an event and a port number. This results in longer lists of trap definitions for the devices. For example, from **epc8221SwitchEvtPort1** to **epc8221SwitchEvtPort12**. Since new firmware versions can generate many more different events, this behavior quickly produces several hundred trap definitions. To limit this overabundance of trap definitions, the trap design has been changed to create only one specific trap for each event type. The port or sensor number is now available in the trap as an index OID within the variable bindings.

In order to recognize this change directly, the "Notification" area in the MIB table has been moved from sysObjectID.0 to sysObjectID.3. This way, unidentified events are generated until the new MIB table is imported. For compatibility reasons, SNMP v1 traps are created in the same way as before.

NET-SNMP

NET-SNMP provides a very widespread collection of SNMP command-line tools (snmpget, snmpset, snmpwalk etc.) NET-SNMP is among others available for Linux and Windows. After installing NET-SNMP you should create the device-specific MIB of the device in NET-SMP share directory, e.g. after

```
c:\usr\share\snmp\mibs
```

or

```
/usr/share/snmp/mibs
```

So later you can use the 'subtree names' instead of OIDs:

```
Name: snmpwalk -v2c -mALL -c public 192.168.1.232 gudeads
```

```
OID: snmpwalk -v2c -mALL -c public 192.168.1.232 1.3.6.1.4.1.28507
```

NET-SNMP Examples



These examples refer to Gude devices that have switchable ports.

Query Power Port 1 switching state:

```
snmpget -v2c -mALL -c public 192.168.1.232 epc822XPortState.1
```

Switch on Power Port 1:

```
snmpset -v2c -mALL -c private 192.168.1.232 epc822XPortState.1 integer 1
```

4.11.1 Device MIB 8291

Below is a table of all device-specific OID 's which can be accessed via SNMP. In the numerical representation of the OID the prefix " 1.3.6.1.4.1.28507 " (Gude Enterprise OID) was omitted at each entry in the table to preserve space. The example for a complete OID would be "1.3.6.1.4.1.28507.98.1.1.1". A distinction is made in SNMP OID 's in between tables and scalars. OID scalar have the extension ".0" and only specify a value. In SNMP tables the "x" is replaced by an index (1 or greater) to address a value from the table.

Name	Description	OID	Type	Acc.
epc8291TrapCtrl	0 = off 1 = Ver. 1 2 = Ver. 2c 3 = Ver. 3	.98.1.1.1.1.0	Integer32	RW
epc8291TrapIPIndex	A unique value, greater than zero, for each receiver slot.	.98.1.1.1.2.1.1.x	Integer32	RO
epc8291TrapAddr	DNS name or IP address specifying one Trap receiver slot. A port can optionally be specified: 'name:port' An empty string disables this slot.	.98.1.1.1.2.1.2.x	OCTETS	RW
epc8291ProdName	The Product Name of the device.	.98.1.1.2.1.0	OCTETS	RO
epc8291FWVersion	Firmware Version of the device.	.98.1.1.2.2.0	OCTETS	RO
epc8291HostName	The configured Host Name.	.98.1.1.2.3.0	OCTETS	RO
epc8291PhysAddress	The MAC address of the device.	.98.1.1.2.4.0	OCTETS	RO
epc8291SerialNumber	The Serial Number of the device. Not available for all devices. Production start 2026.	.98.1.1.2.5.0	Unsigned32	RO
epc8291portNumber		.98.1.3.1.1.0	Integer32	RO

Specifications

	The number of Relay Ports			
epc8291PortIndex	A unique value, greater than zero, for each Relay Port.	.98.1.3.1.2.1.1.x	Integer32	RO
epc8291PortName	A textual string containing name of a Relay Port.	.98.1.3.1.2.1.2.x	OCTETS	RW
epc8291PortState	current state of a Relay Port	.98.1.3.1.2.1.3.x	INTEGER	RW
epc8291PortSwitchCount	The total number of switch actions occurred on a Relay Port. Does not count switch commands which will not switch the relay state, so just real relay switches are displayed here.	.98.1.3.1.2.1.4.x	Integer32	RO
epc8291PortStartupMode	set Mode of startup sequence (off, on , remember last state)	.98.1.3.1.2.1.5.x	INTEGER	RW
epc8291PortStartupDelay	Delay in sec for startup action	.98.1.3.1.2.1.6.x	Integer32	RW
epc8291PortRepowerTime	Delay in sec for repower port after switching off	.98.1.3.1.2.1.7.x	Integer32	RW
epc8291PortResetDuration	Delay in sec for turning Port on again after Reset action	.98.1.3.1.2.1.8.x	Integer32	RW
epc8291FanIndex	None	.98.1.3.5.1.1.x	Integer32	RO
epc8291FanMode	shows the Fan Mode	.98.1.3.5.1.2.x	INTEGER	RW
epc8291FanLevel	shows the actual Fan level	.98.1.3.5.1.3.x	Gauge32	RO
epc8291Buzzer	turn Buzzer on and off	.98.1.3.10.0	Integer32	RW
epc8291ActivePowerChan	Number of supported Power Channels.	.98.1.5.1.1.0	Unsigned32	RO
epc8291PowerIndex	Index of Power Channel entries	.98.1.5.1.2.1.1.x	Integer32	RO
epc8291ChanStatus	0 = data not active, 1 = data valid	.98.1.5.1.2.1.2.x	Integer32	RO
epc8291AbsEnergyActive	Absolute Active Energy counter.	.98.1.5.1.2.1.3.x	Gauge32	RO
epc8291PowerActive	Active Power	.98.1.5.1.2.1.4.x	Integer32	RO
epc8291Current	Actual Current on Power Channel.	.98.1.5.1.2.1.5.x	Gauge32	RO
epc8291Voltage	Actual Voltage on Power Channel	.98.1.5.1.2.1.6.x	Gauge32	RO
epc8291Frequency	Frequency of Power Channel	.98.1.5.1.2.1.7.x	Gauge32	RO
epc8291PowerFactor	Power Factor of Channel between -1.0 and 1.00	.98.1.5.1.2.1.8.x	Integer32	RO
epc8291Pangle	Phase Angle between Voltage and L Line Current between -180.0 and 180.0	.98.1.5.1.2.1.9.x	Integer32	RO
epc8291PowerApparent	L Line Mean Apparent Power	.98.1.5.1.2.1.10.x	Integer32	RO
epc8291PowerReactive	L Line Mean Reactive Power	.98.1.5.1.2.1.11.x	Integer32	RO
epc8291AbsEnergyReactive	Absolute Reactive Energy counter.	.98.1.5.1.2.1.12.x	Gauge32	RO
epc8291AbsEnergyActiveResettable	Resettable Absolute Active Energy counter. Writing '0' resets all resettable counter.	.98.1.5.1.2.1.13.x	Gauge32	RW
epc8291AbsEnergyReactiveResettable	Resettable Absolute Reactive Energy counter.	.98.1.5.1.2.1.14.x	Gauge32	RO
epc8291ResetTime	Time in seconds since last Energy Counter reset.	.98.1.5.1.2.1.15.x	Gauge32	RO
epc8291ForwEnergyActive	Forward Active Energy counter.	.98.1.5.1.2.1.16.x	Gauge32	RO
epc8291ForwEnergyReactive	Forward Reactive Energy counter.	.98.1.5.1.2.1.17.x	Gauge32	RO
epc8291ForwEnergyActiveResettable	Resettable Forward Active Energy counter.	.98.1.5.1.2.1.18.x	Gauge32	RO
epc8291ForwEnergyReactiveResettable	Resettable Forward Reactive Energy counter.	.98.1.5.1.2.1.19.x	Gauge32	RO
epc8291RevEnergyActive	Reverse Active Energy counter.	.98.1.5.1.2.1.20.x	Gauge32	RO
epc8291RevEnergyReactive	Reverse Reactive Energy counter.	.98.1.5.1.2.1.21.x	Gauge32	RO

Specifications

epc8291RevEnergyActiveResettable	Resettable Reverse Active Energy counter.	.98.1.5.1.2.1.22.x	Gauge32	RO
epc8291RevEnergyReactiveResettable	Resettable Reverse Reactive Energy counter.	.98.1.5.1.2.1.23.x	Gauge32	RO
epc8291ResidualCurrent	Actual Residual Current on Power Channel. According Type A IEC 60755. Only visible on models that support this feature.	.98.1.5.1.2.1.24.x	Unsigned32	RO
epc8291LineSensorName	A textual string containing name of a Line Sensor	.98.1.5.1.2.1.100.x	OCTETS	RW
epc8291OVPIIndex	None	.98.1.5.2.1.1.x	Integer32	RO
epc8291OVPSStatus	shows the status of the built-in Overvoltage Protection	.98.1.5.2.1.2.x	INTEGER	RO
epc8291BankPowerIndex	None	.98.1.5.8.1.1.x	Integer32	RO
epc8291BankPowerSource	Power Source of Port Bank	.98.1.5.8.1.2.x	Integer32	RW
epc8291BankPowerVoltage	Actual Voltage of Port Bank	.98.1.5.8.1.3.x	Gauge32	RO
epc8291BankPowerCurrent	Actual Current of Port Bank	.98.1.5.8.1.4.x	Gauge32	RO
epc8291PowerSourceIndex	None	.98.1.5.9.1.1.x	Integer32	RO
epc8291PowerSourceVoltage	Actual Voltage of Power Source	.98.1.5.9.1.2.x	Gauge32	RO
epc8291PowerSourceCurrent	Actual Current of Power Source	.98.1.5.9.1.3.x	Gauge32	RO
epc8291CPUSensorVsystem	System Voltage on CPU Board	.98.1.5.14.1.0	Gauge32	RO
epc8291CPUSensorVaux	Auxiliary Voltage on CPU Board	.98.1.5.14.2.0	Gauge32	RO
epc8291CPUSensorVmain	Main Voltage on CPU Board	.98.1.5.14.3.0	Gauge32	RO
epc8291CPUSensorTcpu	Temperature on CPU Board	.98.1.5.14.4.0	Integer32	RO
epc8291NTPTimeValid	Show if valid Time is received	.98.1.5.15.1.0	INTEGER	RO
epc8291NTPUnixTime	show received NTP time as unixtime (secs since 1 January 1970)	.98.1.5.15.2.0	Unsigned32	RO
epc8291NTPLastValidTimestamp	show seconds since last valid NTP timestamp received	.98.1.5.15.3.0	Unsigned32	RO
epc8291ActiveDCPowerChan	Number of supported DC Power Channels.	.98.1.5.17.1.0	Unsigned32	RO
epc8291DCPowerIndex	Index of Power Channel entries	.98.1.5.17.2.1.1.x	Integer32	RO
epc8291DCVoltage	Actual Voltage on DC Power Channel (eFuse)	.98.1.5.17.2.1.2.x	Gauge32	RO
epc8291DCCurrent	Actual Current on DC Power Channel (eFuse)	.98.1.5.17.2.1.3.x	Gauge32	RO
epc8291DCPower	Actual Power on DC Power Channel (eFuse)	.98.1.5.17.2.1.4.x	Integer32	RO
epc8291SensorIndex	None	.98.1.6.1.1.1.x	Integer32	RO
epc8291TempSensor	actual temperature	.98.1.6.1.1.2.x	Integer32	RO
epc8291HygroSensor	actual humidity	.98.1.6.1.1.3.x	Integer32	RO
epc8291AirPressure	actual air pressure	.98.1.6.1.1.5.x	Integer32	RO
epc8291DewPoint	dew point for actual temperature and humidity	.98.1.6.1.1.6.x	Integer32	RO
epc8291DewPointDiff	difference between dew point and actual temperature (Temp - DewPoint)	.98.1.6.1.1.7.x	Integer32	RO
epc8291ExtSensorName	A textual string containing name of a external Sensor	.98.1.6.1.1.32.x	OCTETS	RW
epc8291ExtActiveInputs	Number of supported Input Channels.	.98.1.6.2.1.0	Unsigned32	RO
epc8291ExtInputIndex	None	.98.1.6.2.2.1.1.x	Unsigned32	RO
epc8291ExtInput	Input state of device	.98.1.6.2.2.1.2.x	INTEGER	RO
epc8291ExtInputToggleCount	Number of times the Input has changed its state.	.98.1.6.2.2.1.3.x	Unsigned32	RO
epc8291ExtInputName		.98.1.6.2.2.1.32.x	OCTETS	RW

	A textual string containing name of the Input			
epc8291ExtInputPortNum		.98.1.6.2.2.1.33.x	Integer32	RO
	Number of external Sensor Port when value greater zero, else device built-in Input.			
epc8291ExtInputBlockIndex		.98.1.6.2.2.1.34.x	Integer32	RO
	Either index of device built-in Input, or index of Input in external sensor.			

4.12 SSL

TLS Standard

The device is compatible with TLS v1.1 to TLS v1.3 standards, but due to lack of security, SSL v3.0, TLS 1.0, and RC4, MD5, SHA1, and DES encryption are disabled. All ciphers use Diffie-Hellman key exchange (Perfect Forward Secrecy).

Creating your own Certificates

The SSL stack is supplied with a specially newly generated self-signed certificate. There is no function to generate the local certificate anew at the touch of a button, since the required random numbers in an embedded device are usually not independent enough. However, you can create new certificates and import them to the device. The server accepts RSA (2048/4096) and ECC (Elliptic Curve Cryptography) certificates.

Usually OpenSSL is used to create an SSL certificate. For Windows for example, there is the light version of Shining Light Productions. There you open a command prompt, change to the directory "C:\OpenSSL-Win32\bin" and set these environment variables:

```
set openssl_conf=C:\OpenSSL-Win32\bin\openssl.cfg
set RANDFILE=C:\OpenSSL-Win32\bin\.rnd
```

Here are some examples for the generation with OpenSSL:

Creation of a self-signed RSA 2048-bit certificate

```
openssl genrsa -out server.key 2048
openssl req -new -x509 -days 365 -key server.key -out server.crt
```

RSA 2048-bit certificate with Sign Request:

```
openssl genrsa -out server.key 2048
openssl req -new -key server.key -out server.csr
openssl req -x509 -days 365 -key server.key -in server.csr -out server.crt
```

 The server keys should be created with "openssl genrsa". The Gude device processes keys in the traditional PKCS#1 format. This can be recognized by the fact that the generated key file starts with "-----BEGIN RSA PRIVATE KEY-----". If the file starts with "-----BEGIN PRIVATE KEY-----", the file is in PKCS#8 format and the key is not recognized. If you have only a key in PKCS#8 format, you can convert it to PKCS#1 with openssl: "openssl rsa -in pkcs8.key -out pkcs1.key".

ECC Certificate with Sign Request:

```
openssl ecparam -genkey -name prime256v1 -out server.key
openssl req -new -key server.key -out server.csr
openssl req -x509 -days 365 -key server.key -in server.csr -out server.crt
```

If you have created your key and certificate, both files are concatenated to one file:

Linux:

```
cat server.crt server.key > server.pem
```



Windows:

```
copy server.crt + server.key server.pem
```

The created server.pem can only be uploaded in the maintenance section of the device.

 If several certificates (Intermediate CRT's) should also be uploaded to the device, one should make sure, that firstly the server certificate and secondly the Intermediates are assembled , e.g:

```
cat server.crt IM1.crt IM2.crt server.key > server.pem
```

 An uploaded certificate will be preserved, when a device is put back to factory defaults .

Performance Considerations

If RSA 4096 certificates are used, the first access to the web server can take 8-10 seconds, because the math unit of the embedded CPU is highly demanded. After that, the parameters are in the SSL session cache, so all other requests are just as fast as with other certificate lengths. For a quick response even on the first access, we recommend RSA 2048-bit certificates that offer adequate security, too.

Support

5 Support

You will find the latest product software on our website at www.gude-systems.com available for download. If you have further questions about installation or operation of the unit, please contact our support team. Furthermore, we present in our support wiki at wiki.gude-systems.com FAQs and configuration examples.

5.1 Data Security

To provide the device with a high level of data security, we recommend the following measures:

- Check that the HTTP password is switched on.
- Set up a sufficiently long HTTP password.
- Configure HTTP Extended Session Authentication.
- Allow access to HTTP via SSL (TLS) only.
- Use TLS 1.3 if possible and avoid TLS 1.1.
- Enable authentication and encryption in SNMPv3 and disable SNMP v2 access.
- Enable STARTTLS or SSL in the e-mail configuration.
- Archive configuration files securely, they contain sensitive information.
- In the IP ACL, enter only the devices that require access to HTTP or SNMP.
- Use SSH if possible, since Telnet is not encrypted.
- Set login for telnet or serial console.
- Use MQTT 3.1.1 only with TLS and password.
- Only permit MQTT CLI commands when the broker is trustworthy.
- Modbus TCP is not encrypted, only activate it in a secure environment.
- Activate "Message Authentication" in RADIUS.

When accessed from the Internet

- Use a randomized password with at least 32 characters.
- If possible, place the device behind a firewall.

5.2 HTTP Performance

Access to the Gude devices via the REST API can normally be conducted from one source every second with HTTP. If accessed from multiple sources simultaneously, it is recommended to adjust the poll interval accordingly.

SSL (TLS) performance

The initial setup for an SSL (TLS) connection results in numerous crypto operations at the start of the connection. If an RSA 2048 certificate is used, the delay at the beginning is about 2-3 seconds, with RSA 4096 the connection establishment can take up to 10 seconds. The delays result from a limitation of the math unit in the embedded CPU. We therefore recommend an ECC 256 certificate, which is significantly more performant to calculate. Previously established connections TLS connections are stored in a TLS Session Cache (or Session Tickets). However, this cache is not always supported by browsers, or it expires after only a short time. Especially browsers (HTTPS clients) of other embedded devices (e.g. media controllers) may be limited in the TLS cache.

A remedy for this can be an HTTP keep-alive connection. Once a connection with HTTP keep-alive is opened, it is closed again after 10 seconds if no data is transferred. If you want to receive data periodically, it is therefore recommended to request the data at intervals of less than 10 seconds (e.g. every 5-8 seconds) after establishing the connection with HTTP keep-alive.

Special TLS 1.3 performance problem with Chrome (MS Edge)

When TLS 1.3 and insecure certificates are used in combination with a web browser with Chromium engine (Google Chrome or MS Edge), performance may be affected, resulting in longer loading times. In this constellation, the Chromium Engine does not correctly support the TLS Session Cache (or Session Tickets) and the math unit of the embedded CPU may be overwhelmed with persistent RSA operations. Possible solutions:

- Use secure certificates (official certificate authority or marked as secure in the OS)
- or keep-alive with poll interval less than 10 seconds
- or use of Firefox browser
- or use ECC 256 (no RSA) certificates
- or configure to "TLS v1.2 only"

5.3 Contact

Worldwide:

GUDE Systems GmbH
Von-der-Wettern-Straße 23
51149 Cologne
Germany

Phone: +49-221-985 925 0
Fax: +49-221-985 925 97
E-Mail: info@gude-systems.com
Internet: www.gude-systems.com

Managing Director: Dr.-Ing. Michael Gude, Andreas Boettcher, Philipp Gude

District Court: Köln, HRB-Nr. 17 7 84
WEEE-number: DE 58173350
Value added tax identification number (VAT): DE 122778228

USA, Canada:

GUDE Systems USA Inc.
405 Lexington Avenue, Suite 2601
New York 10174, USA
E-Mail: contact@gudeamerica.com
Internet: www.gudeamerica.com

5.4 Declaration of Conformity



This product is listed to applicable UL® Standards and requirements tested by SGS® services. Ce produit est homologué selon les normes et les exigences UL applicables par SGS service.



The Waste Electrical & Electronic Equipment (WEEE) directive marking on a product indicates that it should not be disposed of with general waste. Instead, you are encouraged to reuse or recycle the product in accordance with Directive 2012/19/EU of the European Union. Proper disposal of this product will help prevent potential negative effects on the environment and human health, which could otherwise be caused by inappropriate waste handling. Penalties may be applicable for incorrect disposal of this waste, in accordance with your national legislation. For information about recycling this product, please contact your household waste disposal service, your original distributor, or GUDE USA.



5.5 FAQ

1. What can I do if the device is no longer accessible?

- If the status LED is red, the device has no connection to the switch. Unplug and plug in the Ethernet cable. If the status LED is still red, please try connecting other switches. If you are not using a switch but for example connecting a laptop directly to the device, please note that some older laptops require a twisted Ethernet cable.
- If the status LED remains orange for a long time after the Ethernet cable has been plugged in and out, then DHCP is configured but no DHCP server has been found in the network. After a timeout, the last IP address is configured manually.
- If there is a physical connection (status LED lights up green) to the device, but the web server cannot be reached:
 - Try to find the device with GBL_Conf.exe.  See your device in the list, check the TCP/IP parameters set there and correct the values if necessary. The GBL_Conf.exe program works with UDP broadcasts and must therefore be connected to the same local network.
 - If the device has a display, the current IP address can be displayed by repeatedly pressing the "Ok" button. Check whether this IP address meets your expectations.
 - If an IP address has been assigned using DHCP, it is possible to find the device via its MAC address in the DHCP server.

- If the device is not found by GBL_Conf.exe in bootloader mode, you still have the option of resetting the settings to the factory settings [\[30\]](#).

2. Why is a device sporadically no longer accessible when DHCP is activated? or Why does the text "DHCP is configured, but DHCP is not responding!" appear?

- If DHCP is enabled but no DHCP server responds, the last IP address continues to be used. However, the DHCP client tries to reach a DHCP server again every 5 minutes. The DHCP request lasts one minute until it is aborted. During this time the IP address is not accessible! With a static IP address, DHCP should therefore be deactivated in the device.

3. What can be done if the device is no longer accessible, but the buttons still respond?

- Entering or leaving the bootloader mode does not change the state of the relays. In the chapter Maintenance [\[30\]](#) there is a description how to activate the bootloader by pressing the buttons and how to exit the bootloader afterwards. This will restart the firmware without switching relays. However, this procedure does not help if the network itself is incorrectly configured.

4. Where is the serial number stored in the device?

The serial number is not stored in the device, but only visible on the device label. However, you can display the MAC address in the IP address configuration [\[38\]](#). If you contact Gude Systems Support with the MAC address, we will be happy to give you the corresponding serial number.

5. Why does it sometimes take so long to configure new SNMPv3 passwords on the website?

The authentication methods "SHA-384" and "SHA-512" are calculated purely in software, and can not use the crypto hardware. On the configuration page, e.g. "SHA-512", needs up to 45 seconds to calculate the key.

6. Can you enter multiple e-mail recipients?

- Yes. In the E-Mail configuration in the Recipient Address field, it is possible to enter multiple e-mail addresses separated by commas. The input limit is 100 characters.

7. Why did the MIB tables change after the firmware update?

- Since the number of possible event types was increased, the previous trap design resulted in an excess of trap definitions: See Change in Trap Design [\[100\]](#).

8. The message "stream error" appears during the firmware update.

- This happens if the transfer of the new firmware is aborted or takes a very long time and a timeout occurs. Possible remedy:
 - a. If the firmware is transferred via https, try a test transfer via http only.
 - b. Connect a laptop directly to the Gude device via Ethernet.

9. Importing an older firmware

- During a firmware update, old data formats are sometimes converted to new structures. If an older firmware is newly installed, the configuration data and the energy meters may be lost! If the device then does not run correctly, please restore the factory settings (e.g. from the Maintenance Page [\[28\]](#)). Sometimes the text "Upload complete, firmware downgrade not compatible" is displayed during a firmware update. In this special case a downgrade is not possible. This usually happens when a newer hardware component in the device is not supported by an older firmware.

10. Disable switching events

- You can set the sending of syslog, emails etc. when switching ports (only concerns Gude devices with relays) under "System" in the sensor configuration [\[57\]](#).

- 8 -

802.1X 42, 64

- A -

automated Access 64

- B -

Bootloader Mode 25, 30

Button Lock 62

- C -

Certificate-Upload 25, 28

clear DNS-Cache 28

Configuration Management 29

Content of Delivery 10

creating certificates 104

- D -

Data Security 107

Declaration of Conformity 109

Default Display 62

Description 11

device MIB 101

- E -

Electrical Measurement 17

E-Mail 60

Ethernet connector 12

- F -

Factory Reset 25

FAQ 109

Firmware Upload 25

Firmware-Update 28

- G -

GBL_Conf.exe 25

- H -

HTTP 40

HTTP Authentication 83

HTTP Performance 107

HTTPS 40

- I -

Installation 12

IP-ACL 39, 84

IP-Address 38

IPv6 85

- L -

load Configuration 28

- M -

Maintenance 25

messages 85

Modbus TCP 87

MQTT 49, 95

- N -

NTP 50

- O -

Ok button 12

Operating the device directly 23

Overvoltage Protection 16

- P -

Power Ports 34

- R -

Radius 98

RCM Type A 15

Restart 28

RS232 connector 12

- S -

Security Advice 6
Select button 12
Sensor Calibration 21
Sensors 17, 57
SNMP 45, 99
SSH 70
SSL 104
Start-up the device 12
Status LED 12
Status-LED 23
syslog 45

- T -

Technical Specifications 16
Timer 51
Timer Configuration 51
TLS 104

- W -

Watchdog 35



Expert Power Control 8291-2
© 2025 GUDE Systems GmbH
10/9/2025